

The Universal High-End Measuring Machine
for Manufacturers of Threading Tools

ZOLLER
expect great measures

threadCheck | cc



We Stand for Smart Progress

ECONOMICS

The »threadCheck|cc« universal high-end measuring machine from ZOLLER sets new standards for the fully automatic complete measurement of all types of cutting tools, specializing in threading and gear cutting tools.

Experience top class innovation from ZOLLER. The »threadCheck|cc« impresses with its fully automatic and μm -accurate measuring technology in transmitted and incident light – from measuring the outer contour of the tools to operator-independent complete inspection. The integrated tailstock allows tools to be clamped between centers. Automated loading is ensured by the CNC control of the tailstock. All measurement results are recorded clearly and in detail.



Universal multi-sensor and clamping technology

Comprehensive performance range

Innovative high-end design



Innovative Measuring and Inspection Technology

Intelligent multi-sensor technology and the functional full enclosure, in combination with the universal toolholding system including tailstock, make the ZOLLER »threadCheck|cc« unique worldwide for measuring and inspecting all types of precision tools, from taps/thread cutters through to gear cutting tools.

Thanks to the intelligent combination of image processing technology, CNC axes and measuring probes, all important parameters can be measured fully automatically. The distortion-free measurement and inspection of tools with pitches and precision tools of all kinds makes the ZOLLER »threadCheck|cc« the universal genius.



Calibrating measuring machines on site with certified inspection tools and reference standards is an important part of quality assurance at E. ZOLLER GmbH & Co. KG. This enables us to guarantee reliable measurement results and the high precision of your products in accordance with applicable standards.

»threadCheck|cc«

ZOLLER



Accredited calibration laboratory
according to DIN EN ISO/IEC 17025:2018



Quality Management/Environmental Management
according to ISO 9001, VDA 6.4 and ISO 14001

We Stand for Unmatched Precision

TECHNOLOGY

In every new development, factors such as ergonomics, operation and comfort at the workplace play a decisive and competitive role. The »threadCheck|cc« ensures ideal accessibility and allows a highly precise measuring process. Other highlights include the flexibility of the »cockpit« and accessory shelves as well as the innovative multi-sensor system – all aspects to ensure functionality and productivity at the highest level.

Every »threadCheck|cc« is a promise to our customers.

The fully automatic measurement of cutting tools knows no limits. By connecting the »threadCheck|cc« to the ZOLLER »roboSet 2« you step into the future of automation.

Everything about this measuring machine is just right for me. All the components are perfectly coordinated and optimally installed. In the assembly team, I am part of this high-end design – for maximum convenience through to ease of service work.

GEORG BÄR

Part of the ZOLLER assembly team

Production at premium level

Unique operating concept

Outstanding measuring technology



Perfection in Detail

Incident light camera with multi-LED segment illumination and CNC swiveling device – for the inspection and automatic measurement of tool geometries on the circumference, in the chip space and on the face. Simply enter the target parameters in the measuring program dialog and every measured variable is automatically measured and logged: rake angle, radial relief angle, flute contour, chamfer width and many other geometries. The high-performance LEDs, segmented into eight areas, are automatically controlled by the measuring system and ensure optimum illumination of the surface thanks to automatic intensity control – for high precision and repeated accuracy. The sensor equipment is configurable.

Control panel – with active ventilation. The electronic components are installed carefully and securely for defect-free operation. It also ensures optimum accessibility for maintenance and service work.

Swiveling multi-sensor optics carrier »orthoScan« – always finds the perfect viewing angle on the tool. This means that the cutting edge geometries of tools with a pitch, such as taps or hob cutters, can be measured in transmitted light without distortion.

Space-saving and ergonomic sliding door – reliably keeps out external influences such as dirt or extraneous light during measurement. The generous opening, even in the upper area, allows heavy tools to be loaded and unloaded using lifting gear or a crane.

High-end design – with the device base made of hard stone as a high-precision platform for the measuring device tower, spindle and tailstock.

Safety package – in which important operating elements are located at the front of the measuring machine. This means you always have unrestricted access to the emergency stop switch, the reset button, the membrane keypad and the button for starting measuring processes.

Vibration decoupling – the integrated, active vibration damping with automatic level control absorbs external vibration influences at the installation site.



Transmitted light camera with multi-LED illumination – with high-quality, low-distortion optics and telecentric transmitted light, enables the μm -precise measurement of cutting edge contours and step geometry in the silhouette with up to 5 megapixels. The camera has a high frame rate for fast focus and contour recording from the tool rotation. The multi-LED ring light ensures bright, high-contrast illumination of the cutting edge inspection in incident light.

Pneumatic tailstock – with high-precision moving center allows the holding of long and thin tools as a counter center as well as clamping between centers. The smooth-running quick adjustment allows sensitive entry into the tool center and the automatic pressure build-up ensures that the tools are held securely without distortion. In addition, the integrated CNC drive enables automation for loading and clamping between centers.

High-precision spindle »ace« – guarantees μm -accurate holding and clamping of all types of tools and holders. Adaptation to many tool holder systems is guaranteed by the universal adapter tool post changing system. The CNC drive with autofocus and precise angle measuring system offers automatic focusing of the tool cutting edge and recording of the cutting contour.

Software »pilot 4.0« – is self-explanatory, clearly laid out and enables the operator to take reliable measurements. It offers a uniform user interface on all ZOLLER systems – right up to ZOLLER TMS Tool Management Solutions. The individual structure of the software allows customer-specific adaptations to be implemented quickly.

Control unit »cockpit« – offers the operator ergonomics and comfort through individual adjustment options. The »cockpit« can be adjusted in height and position and the 24" TFT color monitor can also be tilted.

Storage options – for adapter tool posts and intermediate sleeves can be found in the integrated shelves. This means you always have your accessories to hand.

High-Precision Sensors for Measuring Technology

With the ZOLLER »threadCheck | cc« you measure without contact in transmitted light and incident light. Equipped with a CNC-controlled swiveling optics carrier and transmitted light and incident light image processing, you can precisely and automatically measure almost anything on cutting tools of any kind as well as on threading and gear cutting tools. The centered multi-LED ring lights ensure ideal illumination on every tool for inspections on the face, on the circumference and in the chip space. The optional electronic measuring probe offers additional measuring options on threading and gear cutting tools.

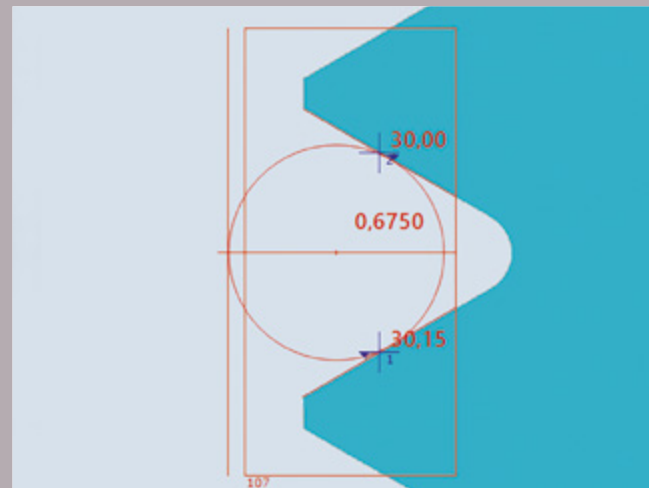

2D transmitted light measurement on the circumference

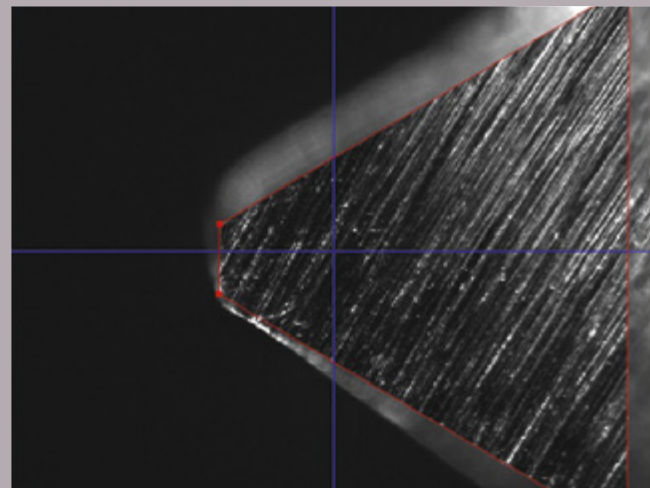

3D contour measurement in the chip space

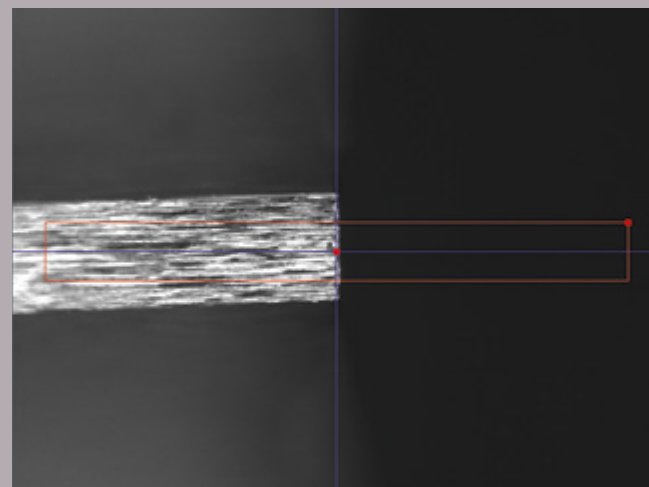

2D incident light measurement on the circumference



Electronic measuring probe

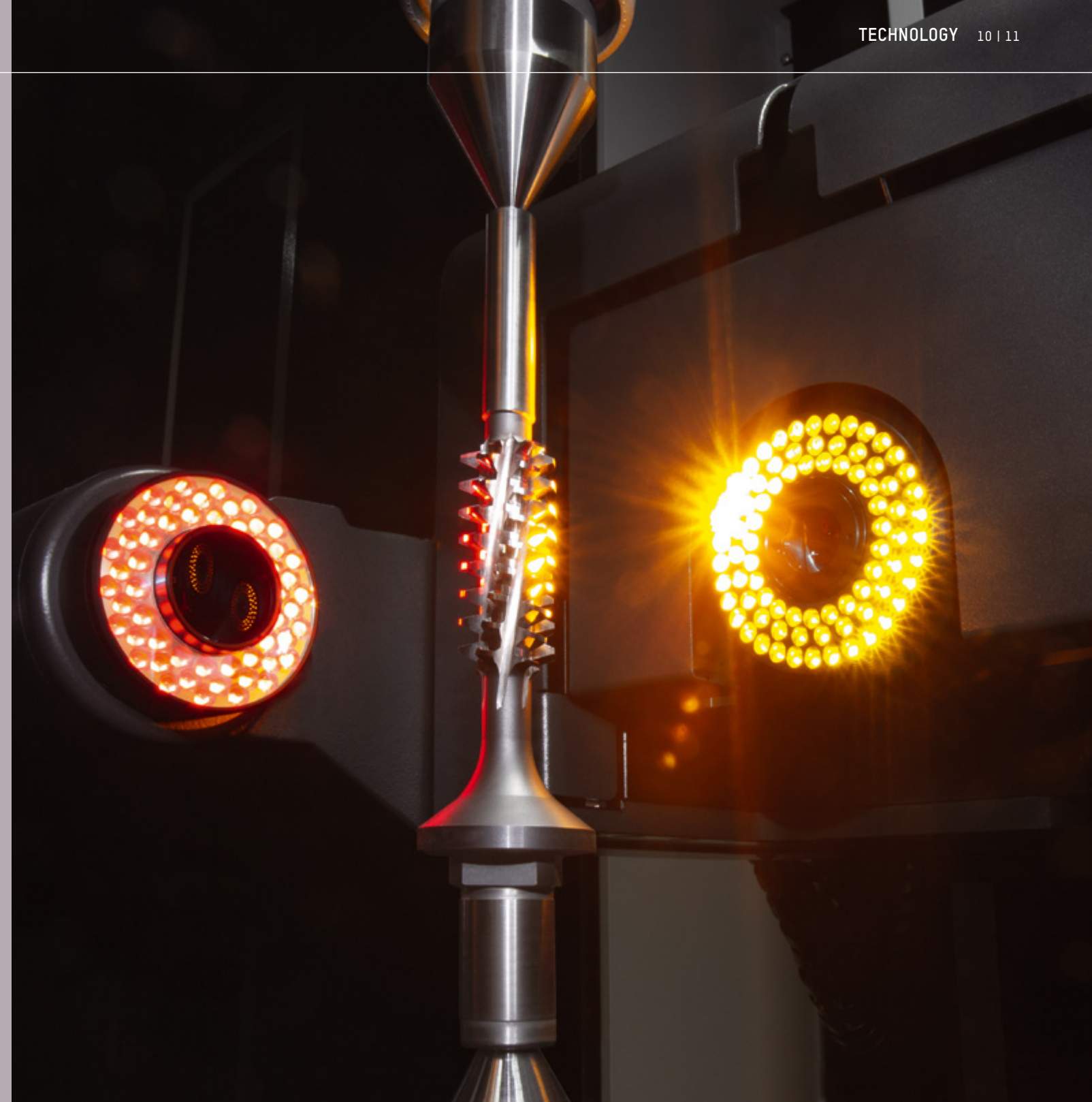

Sensors configuration	
Optics transmitted light	
Transmitted light camera HR70, BF approx. 4.0 x 3.6 mm ²	●
Transmitted light camera 5 Mpx, BF approx. 4.4 x 4.0 mm ²	⊙
Transmitted light camera WF, BF approx. 15.5 x 14.1 mm ²	⊙

Sensors configuration	
Optics incident light	
Incident light camera HR50 Standard, BF approx. 1.1 x 1.0 mm ²	●
Incident light camera HR50 Micro, BF approx. 0.4 x 0.4 mm ²	⊙
Tactile	
Scanning measuring probe	⊙
Switching measuring probe	⊙

● Base model ⊙ Optional

Thread Types in Focus, Fascination in Detail

Measurable parameters at a glance:

- Chamfer diameter d_5
- Chamfer angle β
- Chamfer length L_1
- Chamfer relief h_a
- Thread angle α
- Height of fundamental triangle H
- Root truncation C
- Pitch P
- Pitch diameter d_2
- Major diameter d
- Radial runout major diameter \rightarrow
- Minor diameter d_3
- Taper pitch diameter Δ_2
- Taper major diameter Δ_1
- Taper minor diameter Δ_3
- Flank diameter (offset teeth) D_{off}
- Length of thread part L_2
- Diameter of shank recession d_7
- Shank diameter d_4
- Land width T
- Flute width S
- Length of spiral point L_3
- Slope angle spiral point γ_3
- Inclination angle spiral point λ
- Cutting angle spiral point γ_2
- Cutting angle γ_1
- Flute core diameter d_6
- Flute length L_4
- Major diameter relief h_1
- Pitch diameter relief h_2

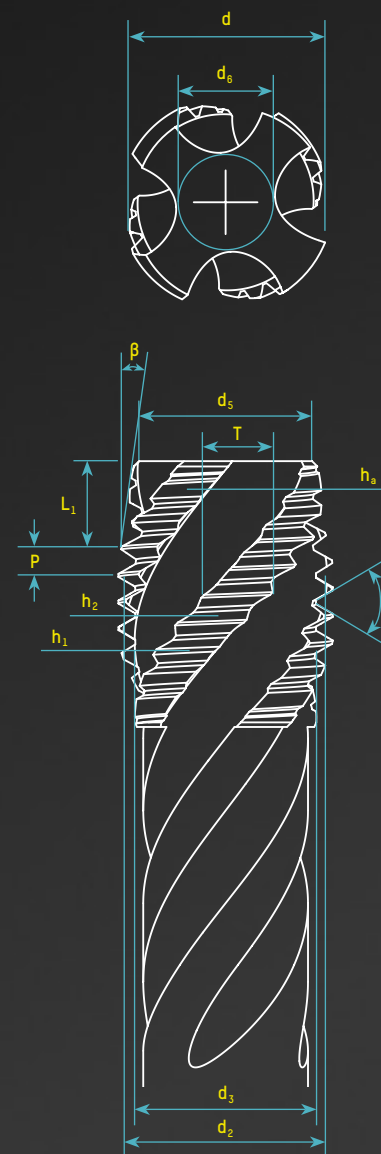

Measuring technology for threading tools – specially developed for the requirements of threading tools, enables fully automatic measurement in transmitted and incident light of all relevant parameters of taps, thread cutters and thread formers.

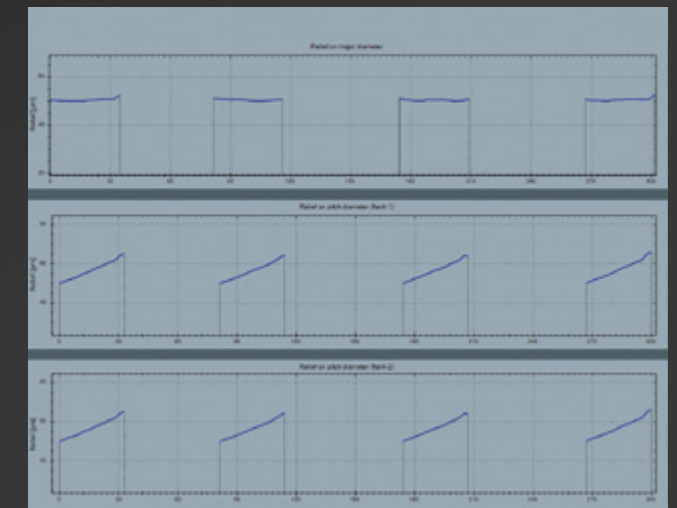

Graphic display – of specific measured values such as the relief on the major or flank diameter, in addition to the numeric measurement results.

High-Precision Spindle »ace«

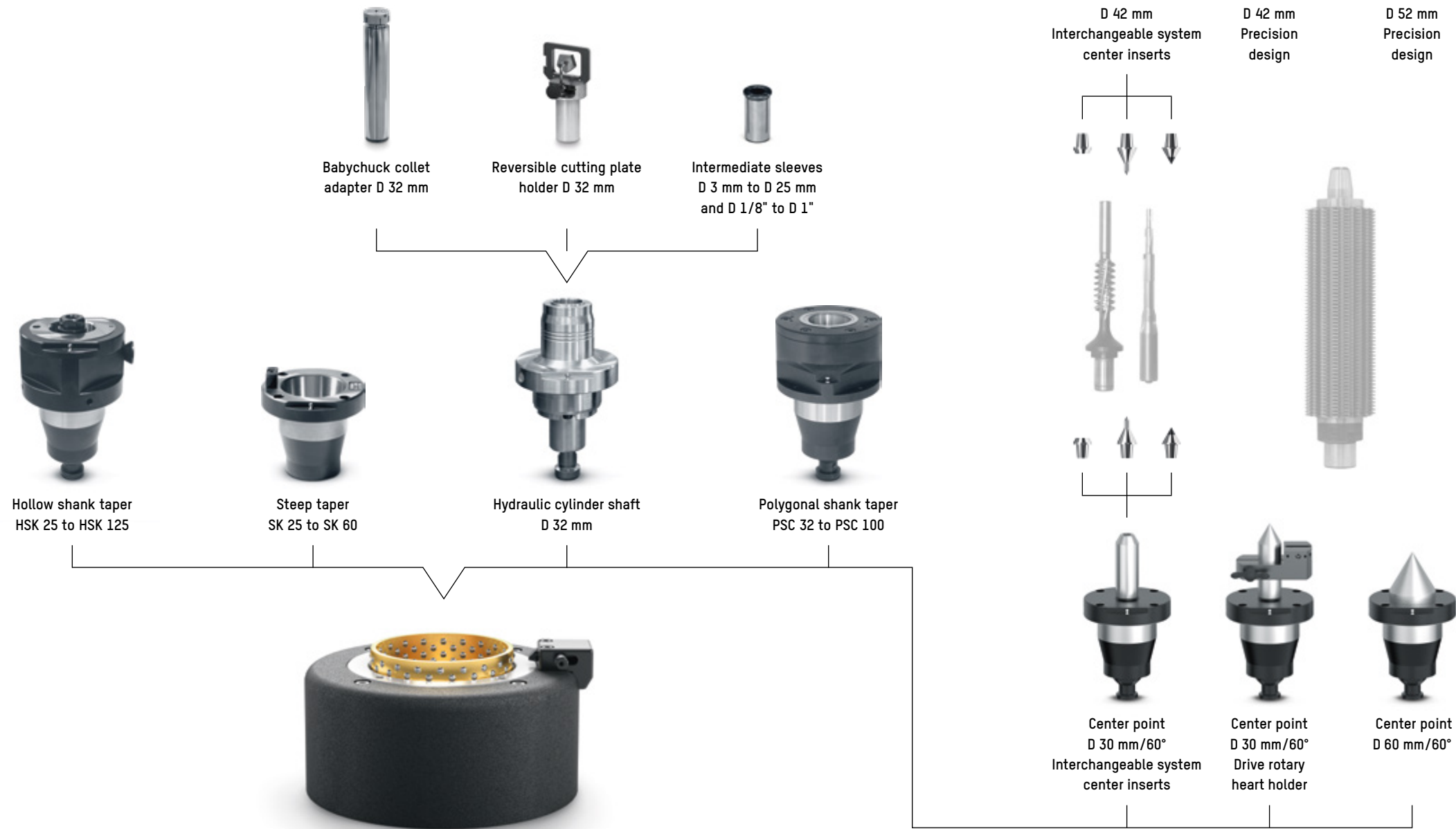

High precision spindle »ace« – with power clamping and quick-change system

- Power-operated tool clamping – constant, independent of the user
- High axial and radial run-out accuracy – better than 2 µm
- Ergonomic spindle handwheel – for safe rotation of the spindle and precise focusing of the tool cutting edge
- Pneumatic spindle brake and indexing – for fixing the spindle in the desired position
- High changing accuracy of adapter tool posts – better than 1 µm
- Quick adapter tool post change – in less than 10 seconds
- Integrated calibration spheres on adapter tool posts – for simple, quick and precise determination of the spindle zero point
- Automatic zero point selection – automatic detection and calibration of the adapter tool post used



»threadCheck|cc« Becomes the Hob Specialist

Based on the ZOLLER »pilot 4.0« software, the »hobCheck« software makes the fast and µm-accurate measurement of gear cutting tools child's play. Cylindrical hobs are measured fully automatically and evaluated in accordance with DIN 3968. By specifying the quality class, the tolerances of the measurement parameters are classified accordingly after measurement. For example, the radial/axial run-out of the inspection collars, form and position deviation of the rake face, form deviation of the cutting edge, tooth thickness, flute direction and much more are determined. The measuring process is fully automatic. Depending on the evaluation options, teeth are focused, measurements are carried out optimally for the measuring task using image processing or measuring probes and the optics carrier is swiveled for certain measurements.

Measurable parameters according to DIN 3968:

- Concentricity deviation on inspection collars
- Concentricity deviation on the clamping surfaces
- Concentricity deviation at the tooth head
- Form and position deviation of the rake faces*
- Individual pitch of the flutes*
- Pitch jump of the flutes*
- Total pitch of the flutes*
- Flute direction over 100 mm cutter length*
- Form deviation of the cutting edge
- Tooth thickness on the reference cylinder
- Milling pitch height in pitch direction between any cutting edges of a helix
- Milling pitch height between cutting edges of a thread
- Engagement pitch
- Pressure pitch
- Axial pitch

* Precondition electronic measuring probe

All highlights at a glance:

- Intuitive graphical user interface
- Automatic assignment of the quality class
- Re-measurement function
- Short measuring times
- Combination of image processing and measuring probe
- Representative documentation

Photo-realistic input dialog
»fored« of measuring program 312
for simple data creation



Fully automatic and time-saving
measurement with transmitted
and incident light image
processing and measuring probe



Results display with extensive
detailed information for
each parameter and re-
measurement function

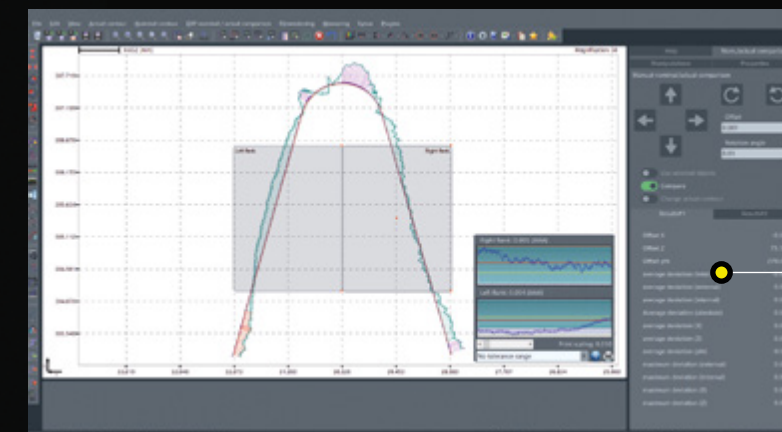

Graphic evaluation of the
form deviation of the cutting edge

Inspection of Protuberance and Tooth Flanks

Measuring program 315

for measuring the protuberance on cylindrical hobs. The amount, height and angle of the protuberance and the edge breakage height on the left and right tooth flank are determined.

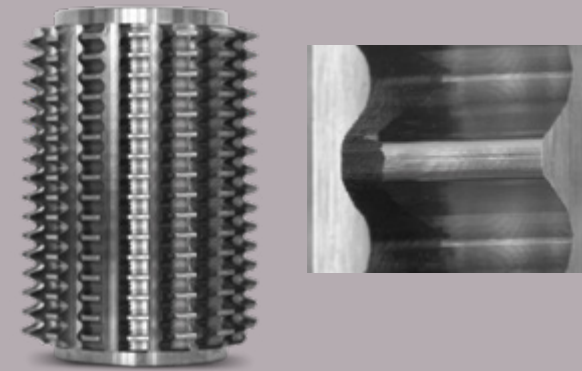
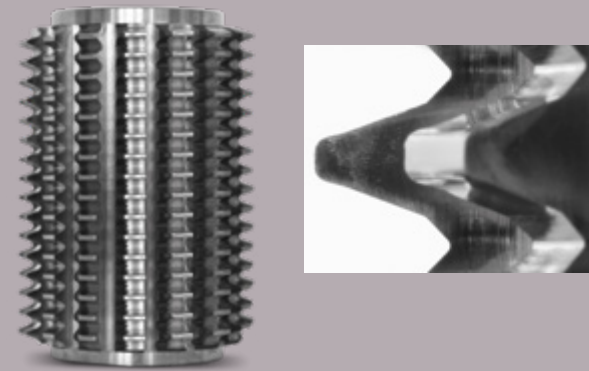

Measuring program 720

for measuring the axial relief on the tooth flanks of hob cutters. The exact contour of the relief is recorded and analyzed with the scanning measuring probe.



Measuring program 315 – Data creation in the photo-realistic input dialog »fored«.

Measure protocol 1 / 1
 JobCheck: zoller 6/5/2024 10:39:10AM
 User: zoller

Identity number: Z311267
 Designation: Wälzfräser Hartmetall Protuberanz
 Normal module: 1.345400
 Accuracy grade (DIN 3698): AAA/AAA
 Number of turns / direction: 3 / Counterclockwise

Cutting groove number: 19
 Hand of flute lead: Straight
 Flute lead: 12.700000
 Pitch height: 4°30'00"
 Pitch angle: 4°30'00"

Tooth depth: 4.2700
 Tooth root height: 1.8300
 Addendum: 2.336700
 Diameter (nom):
 Diameter (max):

Tooth thickness (l): 10°49'00"
 Angle of action: 0°30'00"
 Rate:

No.	Designation	Units	12 bit 1. bit	Actual (from 1/1)	Min	Max	OK
100	Protuberance amount	mm	0.005	0.005	0.005	0.005	✓
101	Protuberance height	mm	0.005	0.005	0.005	0.005	✓
102	Protuberance angle	°	10°30'00"	10°30'00"	10°30'00"	10°30'00"	✓
103	Chamber height	mm	0.005	0.005	0.005	0.005	✓

E. ZOLLER GmbH & Co. KG - Gottlieb-Damier-Str. 19 - D-74385 Plödenheim
 Tel: +49-7144-8970-0 - Fax: +49-7144-806087 - post@zoller.info - www.zoller.info

Representative inspection report – including parameter selection for internal and external use.

Measure protocol 1 / 3
 JobCheck: zoller 6/5/2024 4:02:49PM
 User: zoller

Identity number: Z311266
 Designation: Carbide Hob Cutter with Shaft

E. ZOLLER GmbH & Co. KG - Gottlieb-Damier-Str. 19 - D-74385 Plödenheim
 Tel: +49-7144-8970-0 - Fax: +49-7144-806087 - post@zoller.info - www.zoller.info

Report printout – of all measured axial relief grindings as a graphical progression and angle specification.



Measuring program 315 – Results display with detailed information for each parameter and re-measurement function.

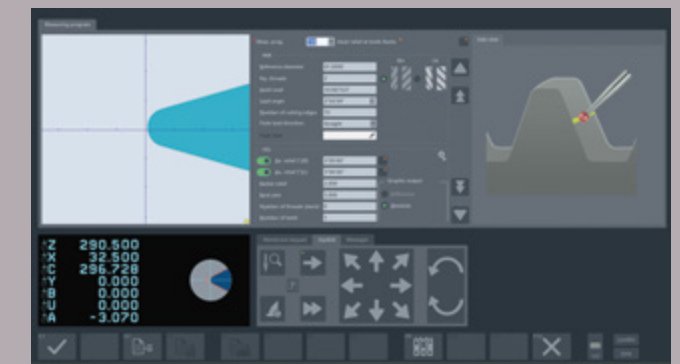

Measuring program 720 – Data creation in the photo-realistic input dialog »fored«.



Measuring program 720 – Result display of all measured undercuts as measured values and graphics including zoom function for a detailed analysis.

Inspection of Pinion and Hob Cutting Wheels

Measuring program 412

for tactile measurement of cutting wheels with measuring probe and evaluation according to DIN 1829. Straight and helical cutting wheels can be measured. The axial run-out, rake angle at the tooth tip and the rake face pitch angle (for helical cutting wheels) are determined.

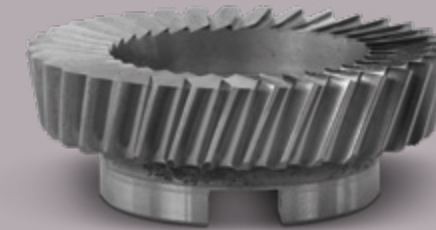

Measuring program 512

for the measurement of hob cutting wheels in transmitted and incident light with evaluation according to DIN 1829. Concentricity deviation on the pitch and tip circle, individual pitch deviation left/right, pitch step left/right, total pitch deviation left/right, tooth thickness variation, rake angle on tooth tip and rake face pitch angle are determined.

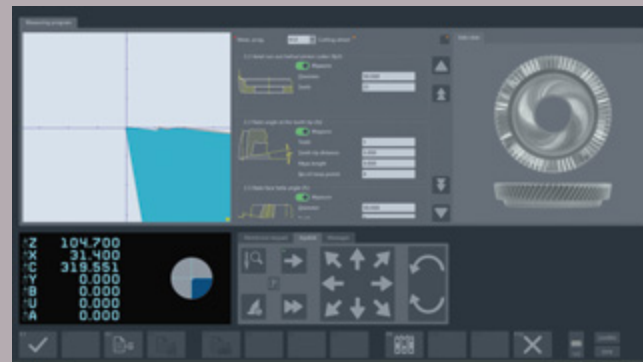

Measuring program 412 – Data creation in the photo-realistic input dialog »ford«.



Representative inspection report – including parameter selection for internal and external use.



Representative inspection report – including parameter selection for internal and external use.



Measuring program 512 – Data creation in the photo-realistic input dialog »ford«.

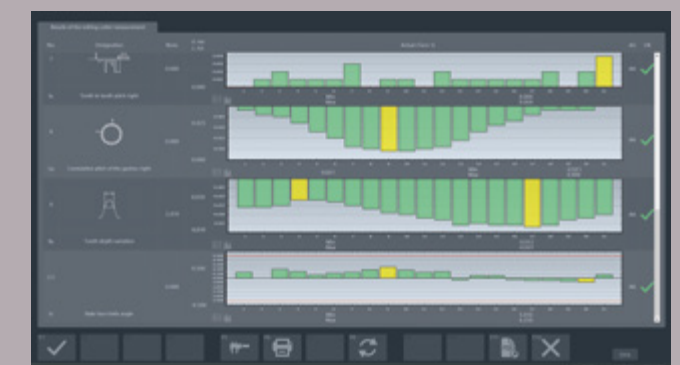

Measuring program 512 – Results display with detailed information for each parameter and re-measurement function.

Precise Wear Control on Hob Cutters

Measuring program 482 for automatic image acquisition of the teeth on circumference and in chip space of cylindrical hobs. Display of the cutting edge images including measuring function for simple, fast determination of the greatest wear. This enables the resharpening process to be optimized and ensures that neither too much nor too little resharpening is carried out.

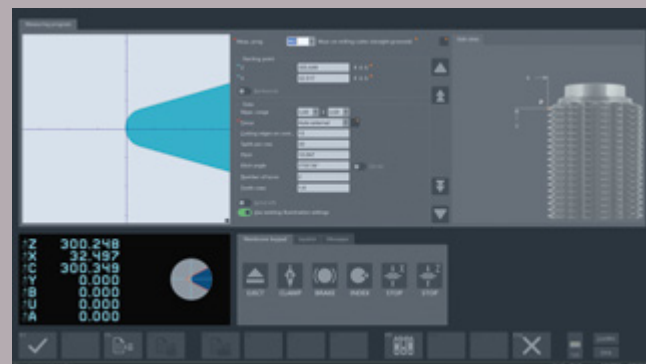
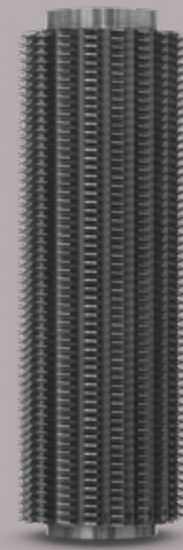

Measuring program 482 – Data creation in the photo-realistic input dialog »fored«.



Measuring program 482 – Overview of the recorded cutting edge images including measuring function for determining wear.

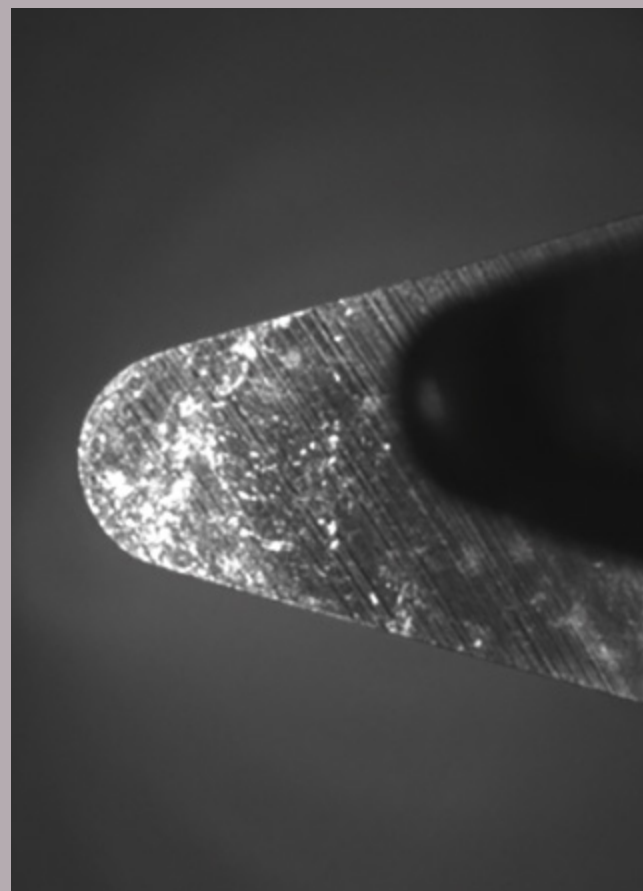

Cutting edge view chip space

Further Software Functions for Hob Cutters:

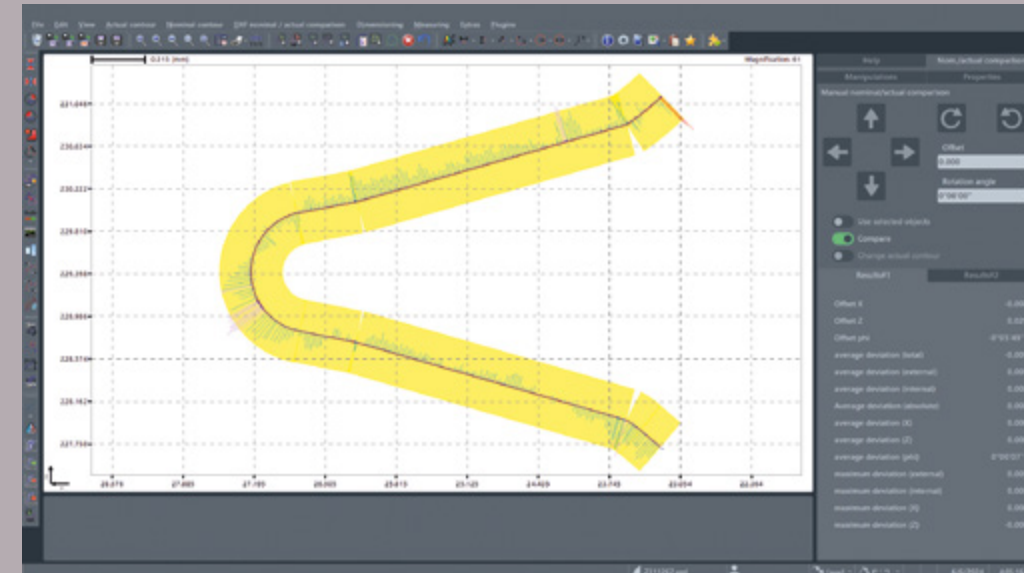

Measuring program 80 – the contour measurement »lasso« enables the automatic nominal/actual comparison of the tooth contours using a DXF nominal contour.

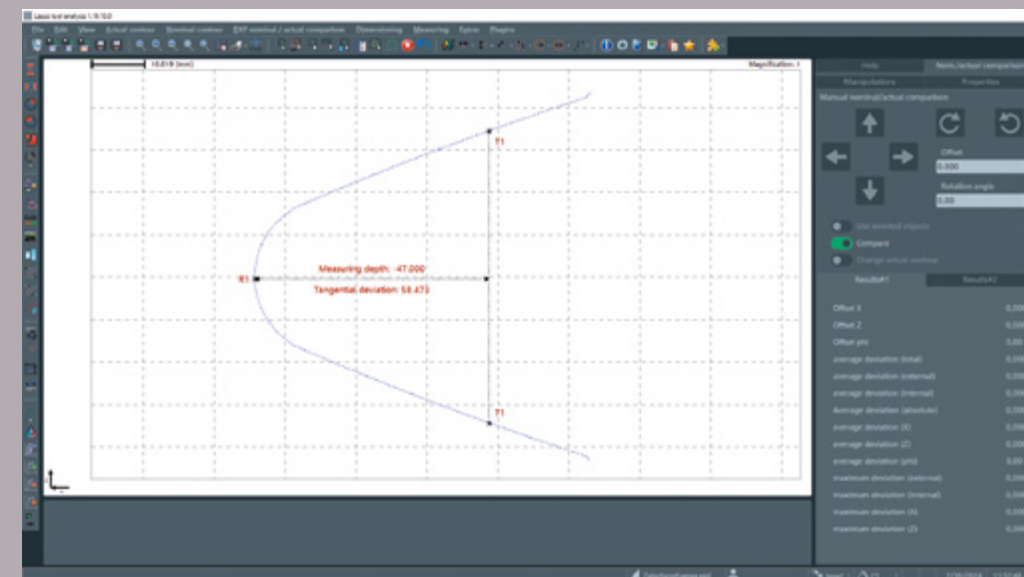

»lasso« tooth form cutter plugin – for automatic determination of the tooth width with freely definable measuring depths starting from the tooth tip.

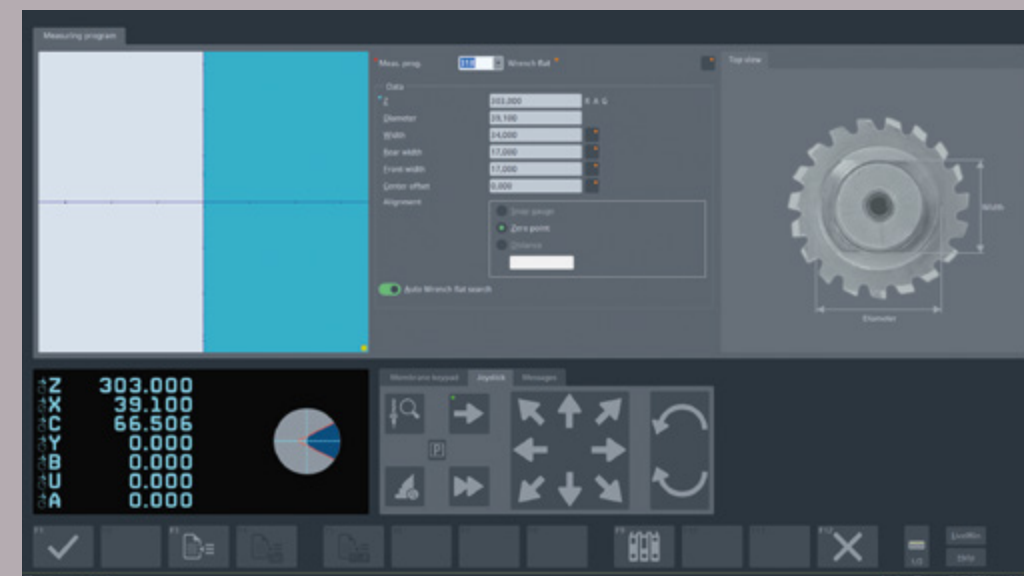

Measuring program 318 – for automatic measurement of the width and center offset of the wrench flat on hobs using the measuring probe.

Solutions for Standard Tools

Further measuring programs at a glance:

- »metis«-Interpreter
- PCD face and corner milling cutters
- Thread cutter (incident light)
- Thread cutter (transmitted light)
- PSC contour measurement
- Variable helix pitch
- Axial run-out
- Christmas tree cutter
- Concentricity thread
- Flank difference face
- HM deep hole drilling heads
- Skiving cutter
- Grinding wheels/packages
- Saw blades
- Cylindricity/taper
- Radius contour »contur« (sector)
- Radius contour end mills (sector)
- »apus«-Calculator
- Radius concentricity
- Roundness measurement

Further software functions at a glance:

- Collective report
- Customer-specific test report
- File logging
- Concentricity and wobble compensation
- Cutter template package
- Drill template package
- Expert template KenTIP
- Cutting edge preparation »skp«
- Cutting edge symmetry and angle
- Symmetry drill head
- Reference tooth via helix angle
- Chisel edge length-face-IMF
- Cut-out length-face
- Corner radius step tools
- Contour correction »coCon«
- Macro editor »lasso«
- »metis«-Generator
- Microsoft SQL server database interface

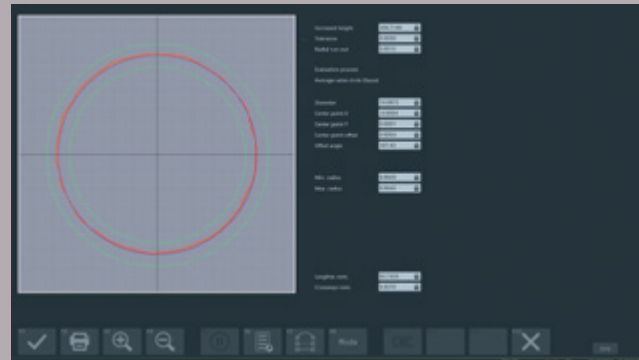

Concentricity check 360° – to automatically determine the radial run-out on circular surfaces (e.g. tool shank) and graphically evaluate the entire contour.

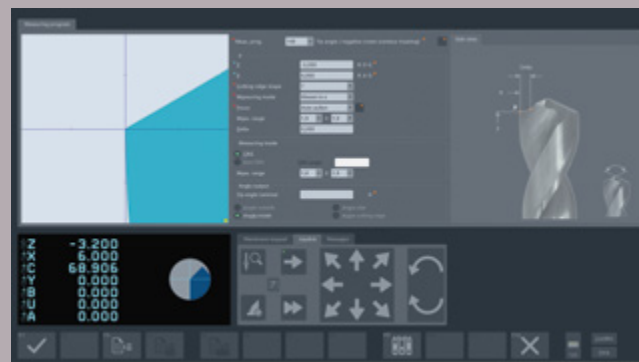

Point angle with hollow grinding – is determined on drilling tools and hollow-ground tool cutting edges from the starting point (outside diameter) to the tool tip or the defined end point by contour tracking.

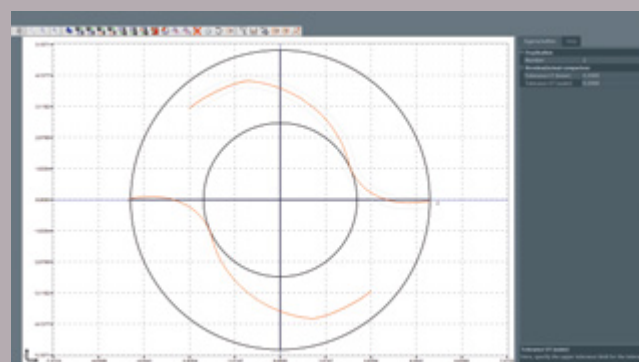

Flute/chip space scan – automatically scans the flute/chip space contour without contact and displays it graphically.

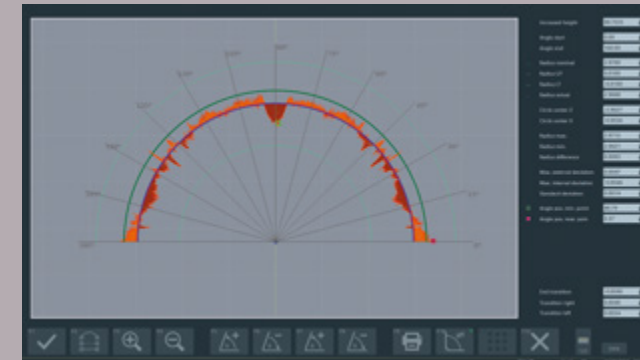

Radius contour »contur« with graphics – for automatic determination of concave and convex radii on the outer contour of tools including adjustable angle sectors with graphic evaluation.

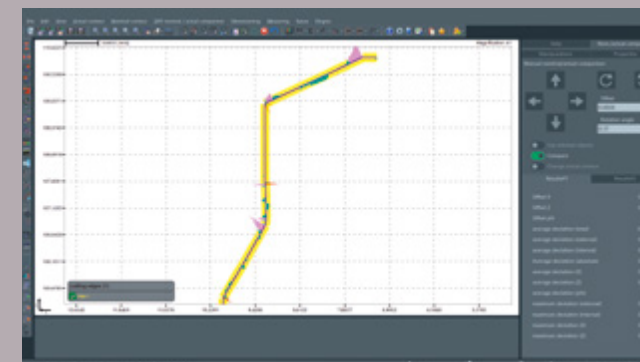

Contour measurement »lasso« – to scan any tool and workpiece contours and perform a nominal/actual comparison or dimensioning of the contour.



Editable inspection report »apus« – to display all measurement results including designations, nominal values, tolerances and much more in tabular form and flexibly in the layout.

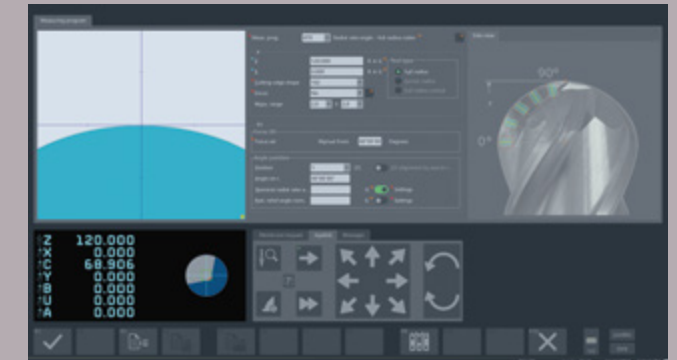

Rake angle on radius cutters – determines the rake angle in the radius segment at the specified angles. Suitable for die, corner and full radius cutters.

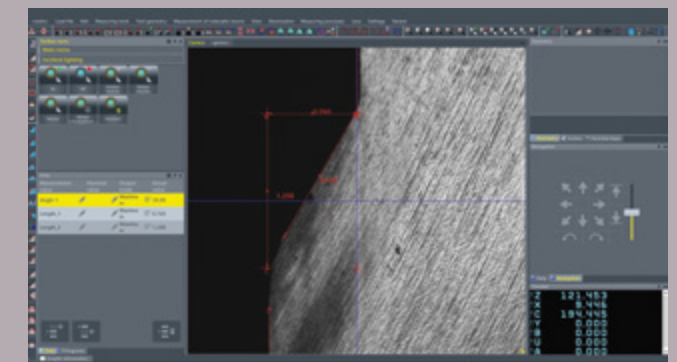

Tool analysis »metis« – measures and documents any contours, radii, angles, distances and defects (wear) in incident light.

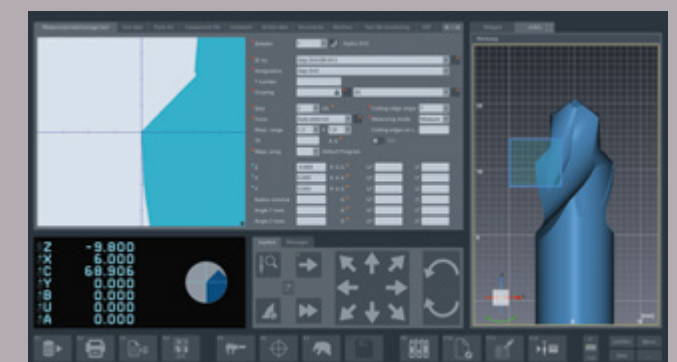

ZOLLER »caz« – the virtual measuring device for PC workstations for external creation of the inspection and measuring process including measuring programs, nominal values and tolerances using the 3D model of the tool before it is manufactured.

»elephant 2.0« – Extremely Easy to Operate

The »elephant 2.0« measuring program wizard enables simple, user-independent measurement and parameterization of standard tools without entering the target data. Using the graphical selection dialog, the desired tool category can be selected and a specific measurement task can be activated. Typical parameters are available depending on the selected tool type. The »elephant 2.0« software is based on innovative AI technology.

Advantages of ZOLLER »elephant 2.0«

- Execution of measurement sequences without special prior knowledge
- Simple selection dialog for defining standard tools
- Storage of measurement sequences in the database



Intelligent searches automatically determine the tool dimensions, including the number of cutting edges. The operator is graphically supported in positioning the cutting edge and measuring window. The tool measurement is then carried out fully automatically and the generated sequence can be saved for repeat measurements and supplemented as required, for example with tolerances.

01. Select tool type, e.g. end mill
> end mill with corner radius

02. Select the desired parameters

03. Active measurement e.g. cutting contour corner radius

04. Measurement results (measured fully automatically and without data input/programming)

Two-Dimensional Guaranteed Quality

The demands in quality management are constantly increasing. That means you must be able to rely on the constant measuring deviations of your machines. In ZOLLER measuring machines, high-precision calibration standards made of Borofloatglas® are used to determine the length measurement deviations based on the DIN EN ISO 10360 standard. In accordance with this standard, at least three measuring sequences (25,326 relationships) are carried out. With this procedure, the accuracy of the ZOLLER measuring machines is documented in two dimensions and can be traced at any time.

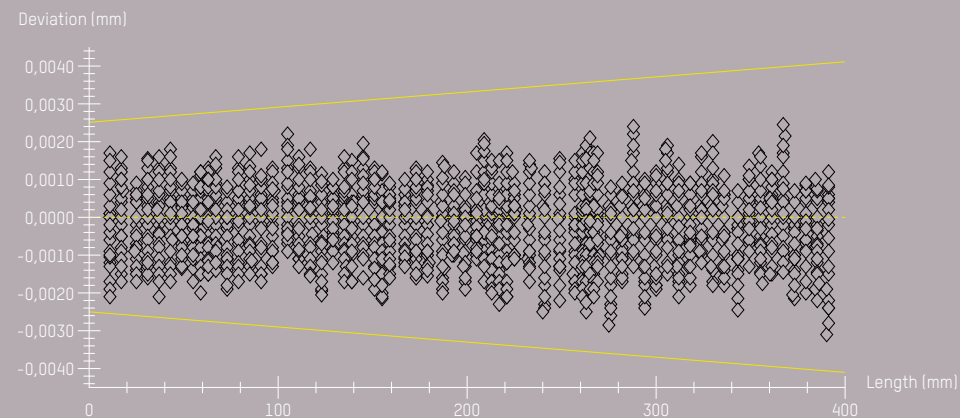

Two-dimensional – based on DIN EN ISO 10360, $E_{xy} = 2.5 \mu\text{m} + (L/250 \text{ mm}) \mu\text{m}$

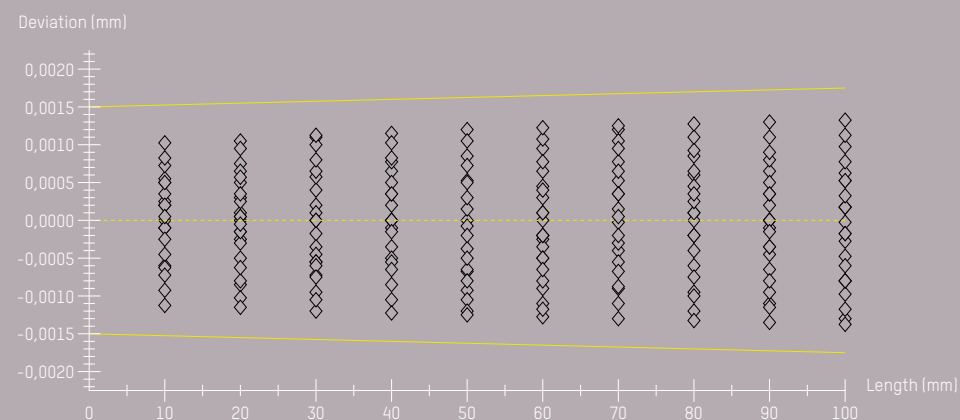

One-dimensional – according to VDI/VDE 2617, $E_x = 1.5 \mu\text{m} + (L/300 \text{ mm}) \mu\text{m}$



Installation Dimensions and Technical Data

Technical data »threadCheck|cc«

Maximum tool length Z	Maximum tool diameter D	Maximum snap gauge diameter d	Travel range Y-axis	Number of axes	Weight
600 mm	420 mm	100 mm	± 50 mm	6-7	~ 1260 kg

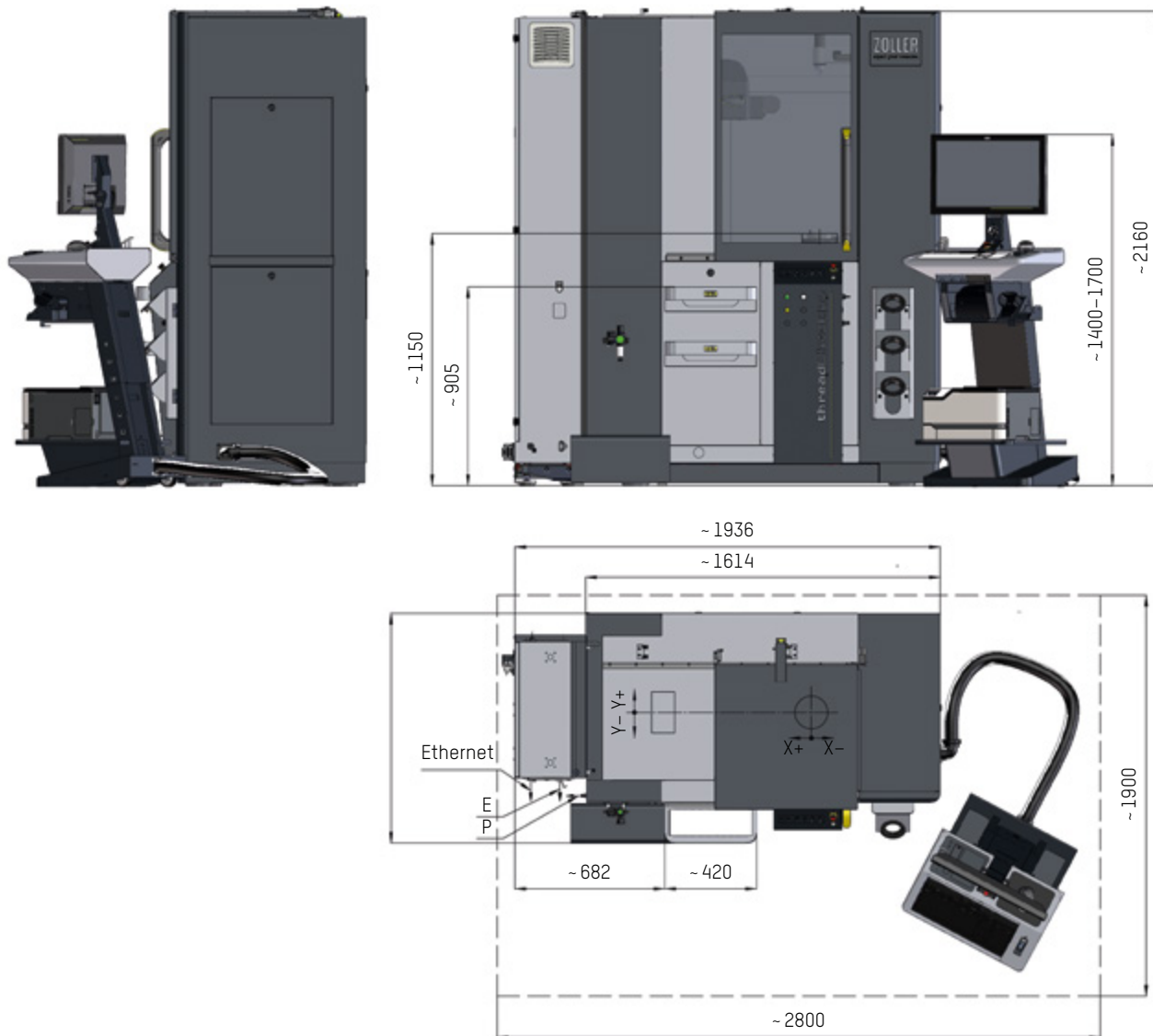

Application	
2D parameters incident light	
Diameter standard 2-100 mm	●
Micro tools 0.1-10 mm	⊙
3D parameters incident light	
Partial	●
Surface-related	●
Measuring tasks	
Threading tools	●
Gear cutting tools	⊙
Sensors configuration	
Optics transmitted light	
Transmitted light camera HR70, BF approx. 4.0 x 3.6 mm²	●
Transmitted light camera 5 Mpx, BF approx. 4.4 x 4.0 mm²	⊙
Transmitted light camera WF, BF approx. 15.5 x 14.1 mm²	⊙
Optics incident light	
Incident light camera HR50 Standard, BF approx. 1.1 x 1,0 mm²	●
Incident light camera HR50 Micro, BF approx. 0.4 x 0.4 mm²	⊙
Tactile	
Scanning measuring probe	⊙
Switching measuring probe	⊙
Tool identification	
RFID Manual »mslz«	⊙

Measuring machine configuration	
Spindle	
High-precision spindle »ace«	●
Hollow encoder	●
Linear drive	
ZOLLER power transmission	●
X-, Y-, Z-axis in column design	●
Optics drive	
Swivel axis incident light	●
Swivel axis incident light & transmitted light	●
Vibration damping	
Leveling element on machine feet	●
Active integrated vibration decoupling	⊙
Accuracy	
$E_{xy} = 2.5 \mu\text{m} + (L/250 \text{ mm}) \mu\text{m}$	●
$E_x = 1.5 \mu\text{m} + (L/300 \text{ mm}) \mu\text{m}$	●

Pioneering Efficiency for your Grinding Shop

The highest potential for greater efficiency lies outside the grinding machine: ZOLLER Solutions stand for your future – we make you more successful. If you can manufacture your parts faster and more efficiently, you can work more economically and invest in the future. If economic progress is your goal, then ZOLLER is your partner.



Made in Germany – Available Wherever You Are

Your Advantage
ZOLLER presence
Global. Close. Personal.

ZOLLER quality is “made in Germany” and there for you, anywhere in the world.

Our company has its own locations and branches at 85 sites in 62 countries, guaranteeing we are close to customers and can provide first-class, personal customer service in local markets.

- Parent company
- Headquarters
- Branch office
- Representative

GERMANY

HEADQUARTERS

E. ZOLLER GmbH & Co. KG
Einstell- und Messgeräte
Gottlieb-Daimler-Straße 19
D-74385 Pleidelsheim
Tel: +49 7144 8970-0
Fax: +49 7144 8970-70191
post@zoller.info | www.zoller.info

ZOLLER NORTH

E. ZOLLER GmbH & Co. KG
Service- und Vertriebszentrum
D-30179 Hannover

ZOLLER EAST

E. ZOLLER GmbH & Co. KG
Service- und Vertriebszentrum
D-04158 Leipzig

ZOLLER WEST

E. ZOLLER GmbH & Co. KG
Service- und Vertriebszentrum
D-40764 Langenfeld

EUROPE

AUSTRIA

ZOLLER Austria GmbH
A-4910 Ried im Innkreis
office@zoller-a.at | www.zoller-a.at

SWITZERLAND

ZOLLER Schweiz GmbH
CH-9016 St. Gallen
info@zoller-ch.com | www.zoller-ch.com

FRANCE

ZOLLER France
F-67380 Lingolsheim
info@zoller.fr | www.zoller.fr

SPAIN + PORTUGAL

ZOLLER Ibérica S.L.
E-08005 Barcelona
correo@zoller.info | www.zoller.info

SWEDEN

ZOLLER Sweden AB
SE-63221 Eskilstuna
info@zoller-se.com | www.zoller.info

TURKEY

ZOLLER Ölçüm Teknolojileri San.ve Tic. Ltd. Sti.
TR-16120 Nilüfer / Bursa
info@zoller-tr.com | www.zoller-tr.com

RUSSIA

LLC ZOLLER Russia
RU-111123 Moscow, Russia
info@zoller-ru.com | www.zoller-ru.com

ISRAEL

ZOLLER Israel GmbH
Ramat Yishay 3009500
info@zoller-il.com | www.zoller.info

POLAND

ZOLLER Polska Sp. z o.o.
63-100 Śrem
biuro@zoller-a.at | www.zoller.net.pl

CZECH REPUBLIC + SLOVAKIA

ZOLLER Czech s.r.o.
602 02 Brno
info@zoller.cz | www.zoller.cz

AMERICA

USA

ZOLLER Inc.
North American Headquarters
USA-48108 Ann Arbor, MI
sales@zoller-usa.com | www.zoller.info/us

ZOLLER Inc. Pacific

USA-90503 Torrance, CA
sales@zoller-usa.com | www.zoller.info/us

CANADA

ZOLLER Canada Inc.
CAN-LSN 864 Mississauga, ON
sales@zoller-canada.com | www.zoller.info/ca

MEXICO

ZOLLER Tecnologías S de R.L. de C.V.
MEX-C.P. 76030 San Angel Querétaro
sales@zoller-mexico.com | www.zoller.info/mx

BRAZIL

ZOLLER do Brasil
BRA-CEP 13284-198 Nova Vinhedo,
Vinhedo - São Paulo
comercial@zoller-br.com | www.zoller-br.com

ASIA

INDIA

ZOLLER India Private Ltd.
IN-Pune 411019 Maharashtra, India
info@zoller-in.com | www.zoller-in.com

CHINA

ZOLLER Shanghai, Ltd.
Asia Pacific Regional Headquarter
RC-201108 Shanghai
info@zoller-cn.com | www.zoller-cn.com

ZOLLER Asia Pacific, Ltd.

RC-Kowloon, Hongkong
info@zoller-cn.com | www.zoller-cn.com

JAPAN

ZOLLER Japan K. K.
JP-564-0037 Osaka, Japan
info@zoller-jp.com | www.zoller-jp.com

THAILAND

ZOLLER (Thailand) Co. Ltd.
Amphur Muang Chonburi, TH-20000 Thailand
info@zoller-in.com | www.zoller-th.com

INDONESIA

ZOLLER Singapore Pte. Ltd
Indonesia Representative Office
Tambun-17510, Bekasi, Jawa Barat
info@zoller-in.com | www.zoller-in.com

SINGAPORE

ZOLLER Singapore Pte. Ltd
SG-199589 Singapore
info@zoller-in.com | www.zoller.info

MALAYSIA

ZOLLER MALAYSIA SDN. BHD.
Malaysia Representative Office
MY-Petaling Jaya | Selangor Darul Ehsan, Malaysia
lau@zoller-my.com | www.zoller-in.com

VIETNAM

ZOLLER Vietnam
VNM-Ho Chi Minh City, Vietnam
info@zoller-in.com | www.zoller-in.com

KOREA

ZOLLER Korea Co., Ltd.
KOR-15119 - Siheung-Si, Gyeonggi-Do, Südkorea
info@zoller-kr.com | www.zoller-kr.com

REPRESENTATIVES

Argentina, Australia, Belgium, Bolivia, Chile, Colombia, Costa Rica, Croatia, Denmark, Estonia, Finland, Great Britain, Hungary, Iran, Ireland, Italy, Lettland, Latvia, Luxembourg, New Zealand, The Netherlands, Norway, Pakistan, Peru, Romania, Saudi Arabia, South Africa, Southern Tyrol, Taiwan, United Arab Emirates, Venezuela.



Your Customer Portal
www.myzoller.com

simple. direct. online.

ZOLLER Solutions

More speed, higher quality, safe processes – with ZOLLER, you increase the efficiency of your production. ZOLLER offers you outstandingly precise devices for adjusting, measuring and testing cutting tools, software, interfaces, cloud services and solutions for the automation of tool processes. You can combine all of this to create your individual system solution – on your way to the smart factory.

Presetting & Measuring

Tool Management

Inspection & Measuring

Automation

Everything from a Single Source.
Everything for your Success.
Everything with ZOLLER Solutions.

ZOLLER
expect great measures

Headquarters in Pleidelsheim

E. ZOLLER GmbH & Co. KG

Tool presetter and measuring machines

Gottlieb-Daimler-Straße 19 | D-74385 Pleidelsheim

Phone: +49 7144 8970-0 | Fax: +49 7144 8970-70191

post@zoller.info | www.zoller.info