

The High-Precision Universal Measuring Machine
for Tool Manufacturers and Grinding Shops

ZOLLER
expect great measures

genius



We Stand for Smart Progress

ECONOMICS

As a tool manufacturer or grinding shop, you have to deliver top quality. The universal measuring machine »genius« uses precise measurement data to provide you with unmistakable proof of the high manufacturing quality of your products.

Prevent complaints and offer your customers perfect and documented quality. Every cutting tool is a specialist. An expert should measure it precisely and verify its quality. With ZOLLER »genius« you can measure over 100 parameters of your precision tools in 2D/3D contactlessly, fully automatically and impressively reliably. Every measured value provides you with the basis for improving the quality of your products.



- State-of-the-art measurement technology
- Comprehensive range of services
- Certified safety

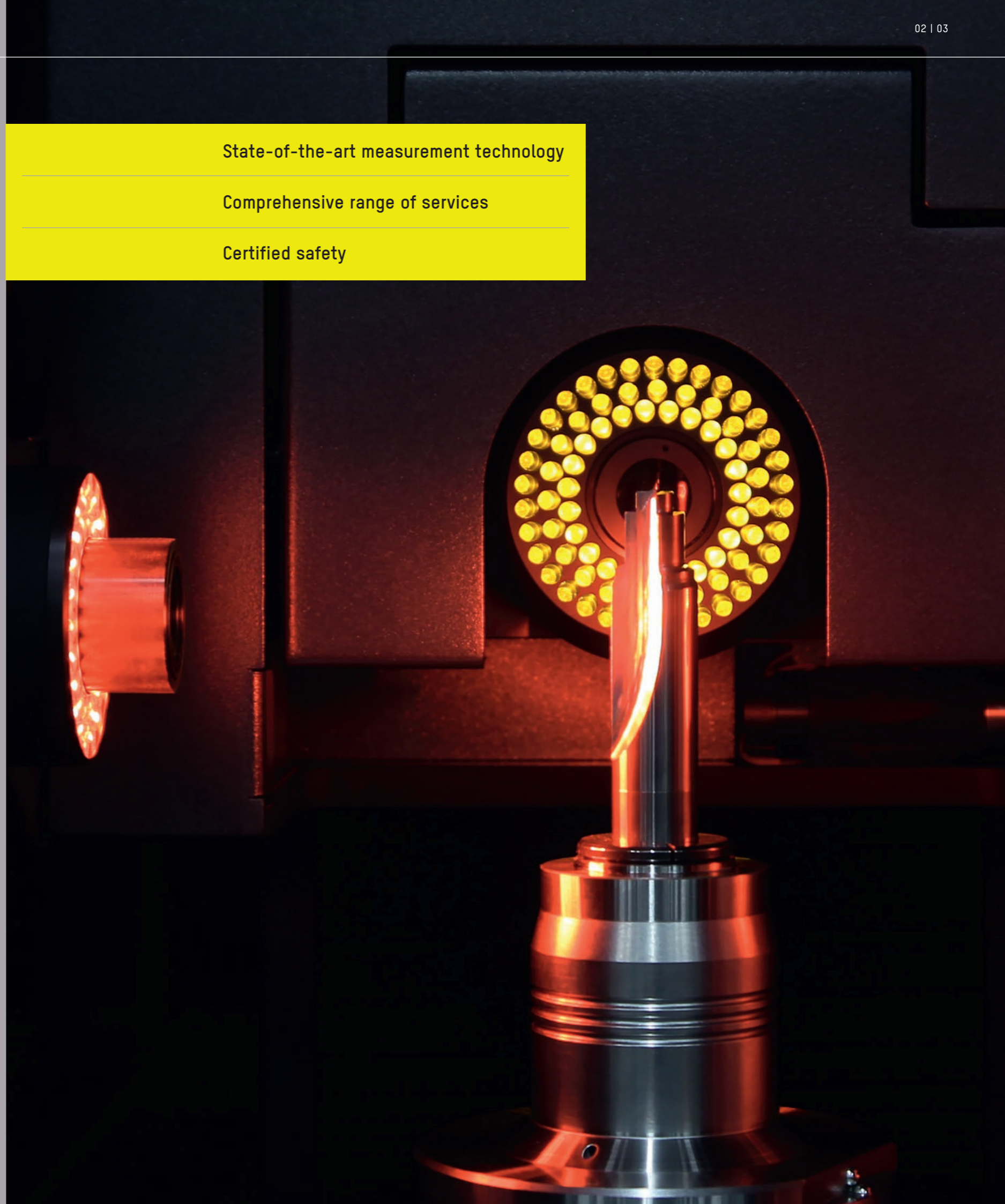

Tool Quality – Automatic and Precise

»genius« means simple operation and high future security. Whether you want to simulate future measuring runs, network your production or exchange tool data with CNC grinding centers in controller format: »genius« makes process and quality assurance ingeniously simple.

ZOLLER »genius« always guarantees you μm -accurate measurement results – even in the production environment. Its metrological precision is based on exact mechanics and highly accurate optics. The operating software »pilot 4.0« offers every user a high level of convenience with customized options. ZOLLER »genius« is already in indispensable use by over 1800 enthusiastic customers worldwide – ingenious measuring technology that impresses.



»genius«



ZOLLER – accredited calibration laboratory
according to DIN EN ISO/IEC 17025:2018

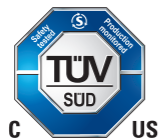

Certified
safety



Quality Management/Environmental Management
according to ISO 9001, VDA 6.4 and ISO 14001

We Stand for Passionated Precision

TECHNOLOGY

A »genius« is easy to handle and tough. The construction of the universal measuring machine is designed for long measuring operations in multi-shift operation directly in production:

Every »genius« is a promise – to our customers. Because a tool measuring machine only becomes outstanding when it makes its excellent precision available to everyone. ZOLLER »genius« achieves the best results thanks to powerful software, extensive automatic functions and clever ergonomic elements. For example, the control unit »cockpit« can be individually adjusted to the operator's needs for user-friendly and comfortable working.

Production at premium level

Customer-oriented overall concept

Maximal operating comfort



I know from many years of assembly experience that the design is particularly solid. As a fitter, I know about the quality of all assemblies – every component passes through my hands.

GERMAN ZELMER

Part of the ZOLLER assembly team

Perfection in Detail

Ergonomic one-hand control handle »eQ« (ergonomic and quick) – to easily move the measuring axes to the correct position in the X, Y and Z directions. The button with the Solutions symbol can be individually configured with additional practical functions, making operation even easier and more convenient.

Transmitted light camera with multi-LED illumination – with high-quality, low-distortion optics and telecentric transmitted light, enables the μm -precise measurement of cutting edge contours and step geometry in the silhouette with up to 5 Mpx. The camera has a high frame rate for fast focus and contour recording from the tool rotation. The multi-LED ring light ensures bright, high-contrast illumination of the cutting edge inspection in incident light.

Space-saving and ergonomic sliding door – reliably keeps out external influences such as dirt or extraneous light during measurement and can be automated as an option.

High-precision spindle »ace« – guarantees μm -precise holding and clamping of tools and fixtures of all kinds. Adaptation to many tool holder systems is guaranteed by the universal adapter tool post changing system. The CNC drive with autofocus and precise angle measuring system offers automatic focusing of the tool cutting edge and recording of the cutting contour.

»genius« TÜV and UL/CSA Approved

Every »genius« measuring machine is certified according to international IEC/EN 61010-1 and cNRTLus standard.

Proven and certified safety.



Separate electronics – decouples electronic heat sources from the measuring process and enables optimum maintenance access.

Incident light camera with multi-LED segment illumination and CNC swivelling device – for the inspection and automatic measurement of tool geometries on the circumference, in the chip space and on the face. Simply enter the target parameters in the measuring program dialog and every measured variable is automatically measured and logged: rake angle, radial relief angle, flute contour, chamfer width and many other geometries. The high-performance LEDs, segmented into eight areas, are automatically controlled by the measuring system and ensure optimum illumination of the surface thanks to automatic intensity control – for high-precision and repeatability.

Software »pilot 4.0« – is self-explanatory, clearly laid out and enables the operator to take reliable measurements. It offers a uniform user interface on all ZOLLER systems – right up to ZOLLER TMS Tool Management Solutions. The individual structure of the software allows customer-specific adaptations to be implemented quickly.

Control unit »cockpit« – offers the operator ergonomics and comfort through individual adjustment options. The »cockpit« can be adjusted in height and position and the 24" TFT color monitor can also be tilted.

Storage options – for adapter tool posts and intermediate sleeves can be found in the integrated shelves: in the interior for intermediate sleeves and on the side for adapter tool posts. This means you always have your accessories to hand.



High-Precision Optics for Tool Measurement Technology

With »genius« you measure without contact in transmitted light and incident light – benefit from ZOLLER multi-sensor technology, optimally adapted to the special conditions on precision tools. The centered multi-LED ring lights ensure ideal illumination on every tool for inspections on the face, on the circumference and in the chip space. With ZOLLER »genius« you can measure almost anything on tools precisely, fully automatically and without contact. No matter how complex the tool is.

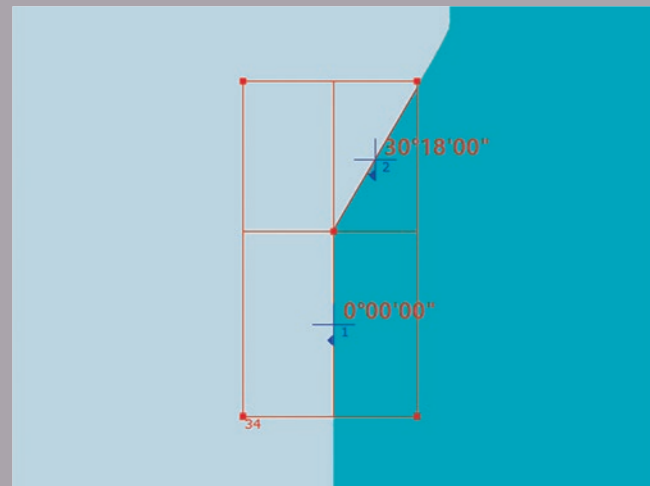

2D-transmitted light measurement on the circumference

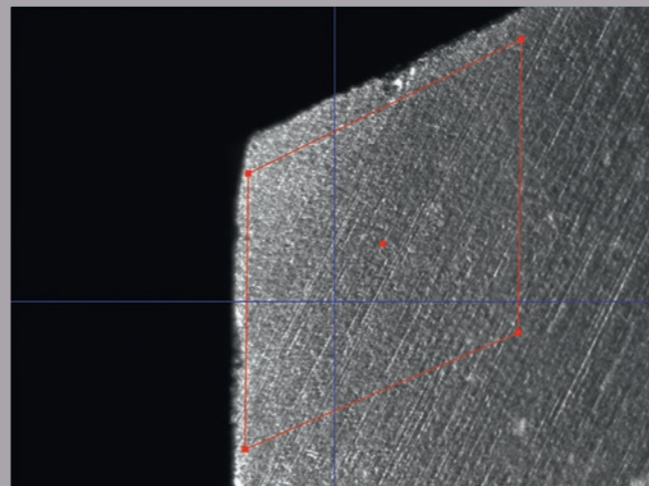

3D contour measurement in the chip space

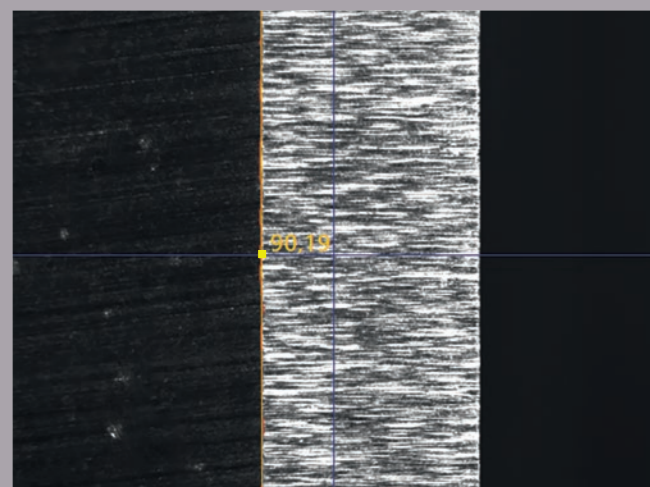

2D incident light measurement on the circumference

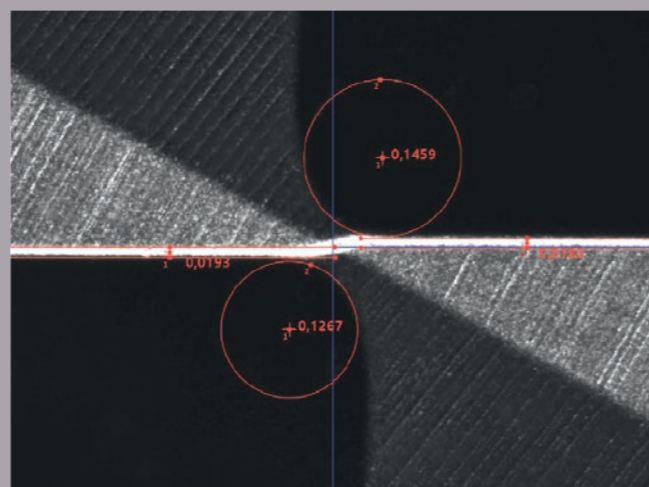

2D incident light measurement on the face



Sensors configuration	
Optics transmitted light	
Transmitted light camera HR70, BF approx. 4.0 x 3.6 mm ²	●
Transmitted light camera 5 Mpx, BF approx. 4.4 x 4.0 mm ²	⊙
Transmitted light camera WF, BF approx. 15.5 x 14.1 mm ²	⊙

Sensors configuration	
Optics incident light	
Incident light camera HR50 Standard, BF approx. 1.1 x 1.0 mm ²	●
Incident light camera HR50 Micro, BF approx. 0.4 x 0.4 mm ²	⊙
Tactile	
Scanning probe	⊙

● Base model ⊙ Optional

High-Precision Spindle »ace«

Advantages of the ZOLLER high-precision spindle

- Clamp everything. Measure everything. Accelerate everything.
- Fast, μm -precise changeover
- Universal for all tool holders

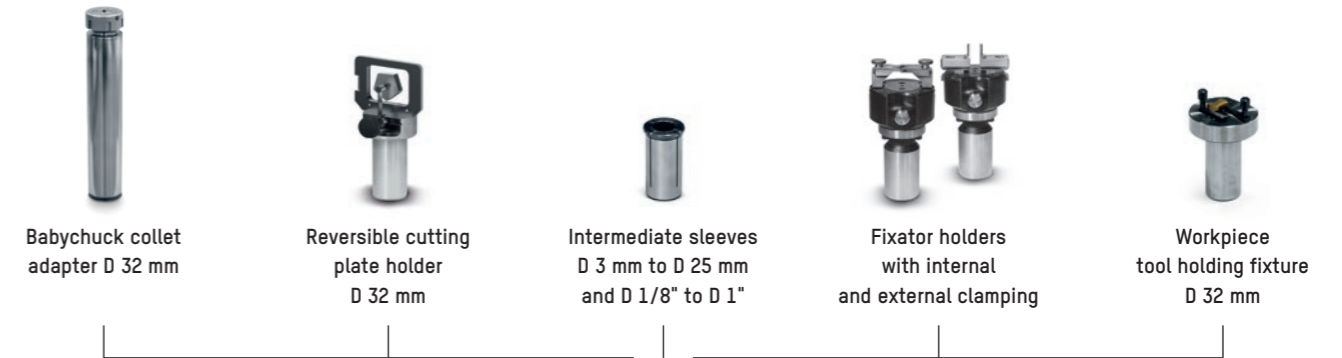

Hollow shank taper
HSK 25 to HSK 125



Steep taper
SK 25 to SK 60



Polygonal shank taper
PSC 32 to PSC 100



Hydraulic cylinder shaft
D 32 mm

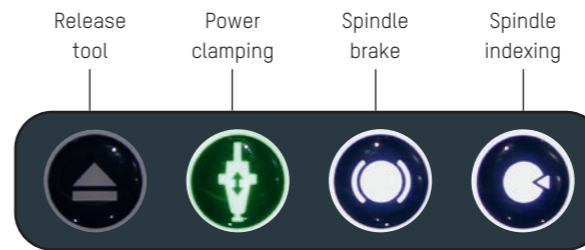

High-precision spindle »ace« – with power clamping and quick-change system

Power-operated tool clamping – constant, independent of the user

High axial and radial run-out accuracy – better than $2 \mu\text{m}$

Pneumatic spindle brake and indexing – for fixing the spindle in the desired position

High changing accuracy of adapter tool posts – better than $1 \mu\text{m}$

Quick adapter tool post change – in less than 10 seconds

Integrated calibration spheres on adapter tool posts – for simple, quick and precise determination of the spindle zero point

»elephant 2.0« – Extremely Easy to Operate

The measuring program wizard »elephant 2.0« enables simple, user-independent measurement and parameterization of standard tools without entering the target data. Using the graphical selection dialog, the desired tool category can be selected and a specific measurement task can be activated. Typical parameters are available depending on the selected tool type.

Advantages of ZOLLER »elephant 2.0«

- Execution of measurement sequences without special prior knowledge
- Simple selection dialog for defining tool categories
- Storage of measurement sequences in the database



The software »elephant 2.0« is based on innovative AI technology. Intelligent searches automatically determine the tool dimensions, including the number of cutting edges. The operator is graphically supported in positioning the cutting edge and measuring window. The tool measurement is then carried out fully automatically and the generated sequence can be saved for repeat measurements and supplemented as required, for example with tolerances.

01. Select tool type, e.g. end mill > end mill with corner radius

02. Select the desired parameters

03. Active measurement e.g. cutting contour corner radius

04. Measurement results (19 items, measured fully automatically and without data input/programming)

The software interface shows a grid of tool icons, a parameter selection list for a 'Shank cutter with corner radius', a graphical measurement window with a blue curve, and a table of measurement results. The table includes columns for 'Measurement', 'Value', 'Unit', and 'Cut', with 19 rows of data.

Software »expert« – Intelligent, Simple, Ingenious

»expert« is the specialist for measurements on precision tools – based on the ZOLLER software »pilot 4.0«. The intelligent software generates the optimum measuring sequence from the selected parameters. Fully automatic, reproducible and with photorealistic parameter selection. The parameters to be measured can be selected easily, quickly and tool-specifically for the measuring program sequence using checkboxes. Simply select and confirm the parameters to be measured – and the measurement sequence starts.

Thanks to the high-resolution live image display, the navigation menu and the virtual ZOLLER joystick, the exact and unique definition of the parameters to be measured can be carried out reliably. The universal and operator-independent measuring program generator measures tools in transmitted and incident light, in the chip space, on the circumference and on the face geometry. »expert« enables fully automatic measurement sequences from random sampling to 100% inspection with minimum effort and complete transparency.

Measuring program selection

Current camera image of the tool

Measuring window

Current position information of the CNC axes

2D measuring routine

Selection of measuring perspective, e.g. circumference, chip space and face

Photorealistic representation of the geometry to be measured on the tool for easy orientation

Selection of the parameters to be measured to define the nominal values and tolerances

Navigation display

Virtual joystick for aligning and positioning the sensors

Softkeys for tool clamping and control of the tool-holding spindle as well as manual axis clamping

Function buttons with self-explanatory icons

Option	Nominal value	Tol.	Para.
<input checked="" type="checkbox"/> Focus	180°00'00"		
<input type="checkbox"/> Ref tooth search			
<input checked="" type="checkbox"/> Helix angle	40°00'00"		
<input checked="" type="checkbox"/> Protect.land angle	4°00'00"		
<input checked="" type="checkbox"/> Radial relief angle 1	16°00'00"		
<input checked="" type="checkbox"/> Radial relief angle 2	30°00'00"		
<input type="checkbox"/> Radial relief angle 3			
<input checked="" type="checkbox"/> Radial land width	0.1000		
<input checked="" type="checkbox"/> Radial land width 2	0.5000		
<input type="checkbox"/> Tooth width			
<input type="checkbox"/> Flute width			
<input type="checkbox"/> Tooth height			
<input type="checkbox"/> Tooth height 2			

Z 114.6944
 X 5.9909
 C 59.5020
 Y 0.0000
 B 0.0000

EJECT CLAMP BRAKE INDEX
 STOP STOP STOP

F1 F2 F3 F4 F5 F6 F7 F8 F9 F10 F11 F12 LiveWin Help

ZOLLER [mm] [° ' "] 11/14/2023 11:27:31 AM

Software Functions for Maximum Performance

Further measuring programs at a glance:

- »metis«-Interpreter
- PCD face and corner milling cutters
- Thread cutter (incident light)
- Thread cutter (transmitted light)
- PSC contour measurement
- Variable helix pitch
- Axial run-out
- Christmas tree cutter
- Concentricity thread
- Flank difference face
- HM deep hole drilling heads
- Skiving cutter
- Grinding wheels/packages
- Saw blades
- Cylindricity/taper
- Radius contour »contur« (sector)
- Radius contour end mills (sector)
- »apus«-Calculator
- Radius concentricity
- Roundness measurement

Further software functions at a glance:

- Collective report
- Customer-specific test report
- File logging
- Concentricity and wobble compensation
- Cutter template package
- Drill template package
- Expert template KenTIP
- Cutting edge preparation »skp«
- Cutting edge symmetry and angle
- Symmetry drill head
- Reference tooth via helix angle
- Chisel edge length-face-IMF
- Cut-out length-face
- Corner radius step tools
- Contour correction »coCon«
- Macro editor »lasso«
- »metis«-Generator
- Microsoft SQL server database interface

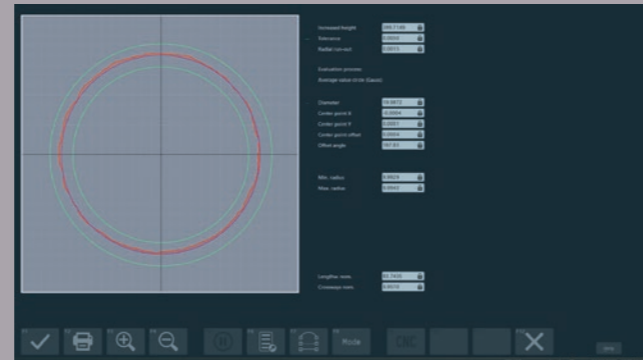

Concentricity check 360° – to automatically determine the radial run-out on circular surfaces (e.g. tool shank) and graphically evaluate the entire contour.



Point angle with hollow grinding – is determined on drilling tools and hollow-ground tool cutting edges from the starting point (outside diameter) to the tool tip or the defined end point by contour tracking.

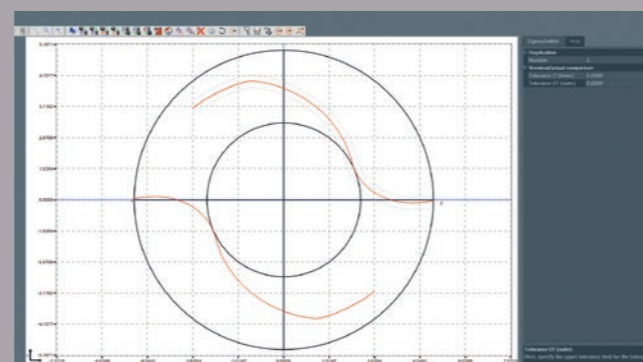

Flute/chip space scan – automatically scans the flute/chip space contour without contact and displays it graphically.

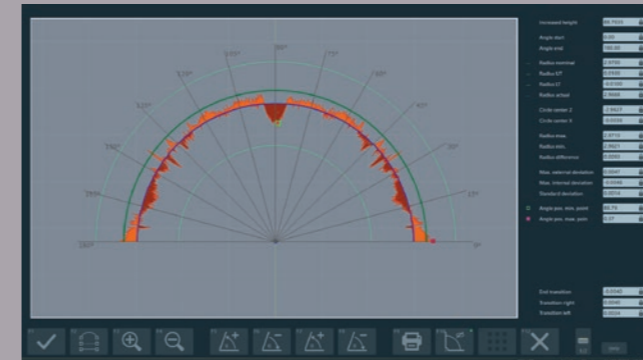

Radius contour »contur« with graphics – for automatic determination of concave and convex radii on the outer contour of tools including adjustable angle sectors with graphic evaluation.

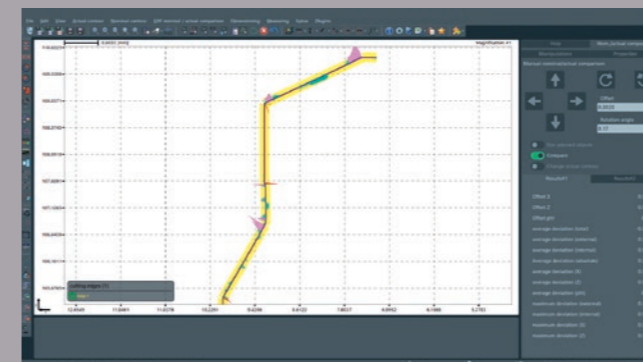

Contour measurement »lasso« – to scan any tool and workpiece contours and perform a nominal/actual comparison or dimensioning of the contour.

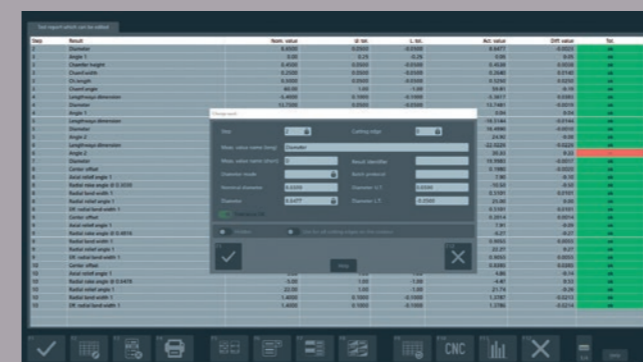

Editable inspection report »apus« – to display all measurement results including designations, nominal values, tolerances and much more in tabular form and flexibly in the layout.

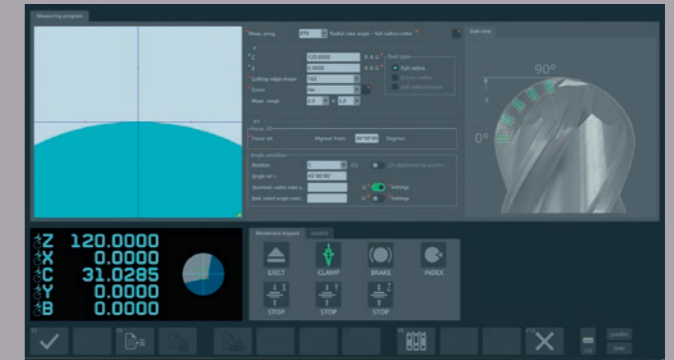

Rake angle on radius cutters – determines the rake angle in the radius segment at the specified angles. Suitable for die, corner and full radius cutters.

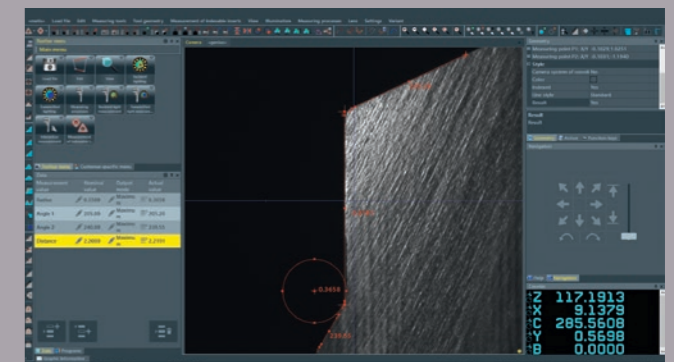

Tool analysis »metis« – measures and documents any contours, radii, angles, distances and defects (wear) in incident light.

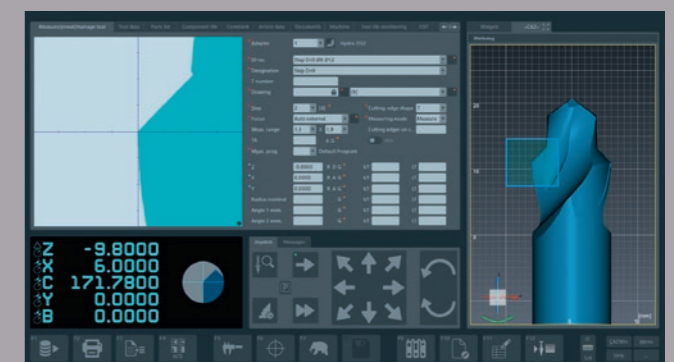

ZOLLER »caz« – the virtual measuring device for PC workstations for external creation of the inspection and measuring process including measuring programs, nominal values and tolerances using the 3D model of the tool before it is manufactured.

»genius« Becomes a Thread Specialist

Would you also like to measure tools with a pitch without contact, distortion-free and with μm -accuracy? Expand your ZOLLER »genius« to the »threadCheck«: thanks to six CNC axes and the swivelling multi-sensor optics carrier »orthoScan« you can measure all types of cutting tools automatically, quickly and with absolute precision. With a swivel range of -30° to 30° , »orthoScan« eliminates distortions caused by inclination when measuring threading tools. The measuring software guides you intuitively through the tool data creation by selecting the thread type and size as well as the parameters to be checked. »threadCheck« combines technology and software specification to create the ingenious ZOLLER thread class.



ZOLLER thread measuring program – for metric ISO, ANSI and Whitworth pipe threads

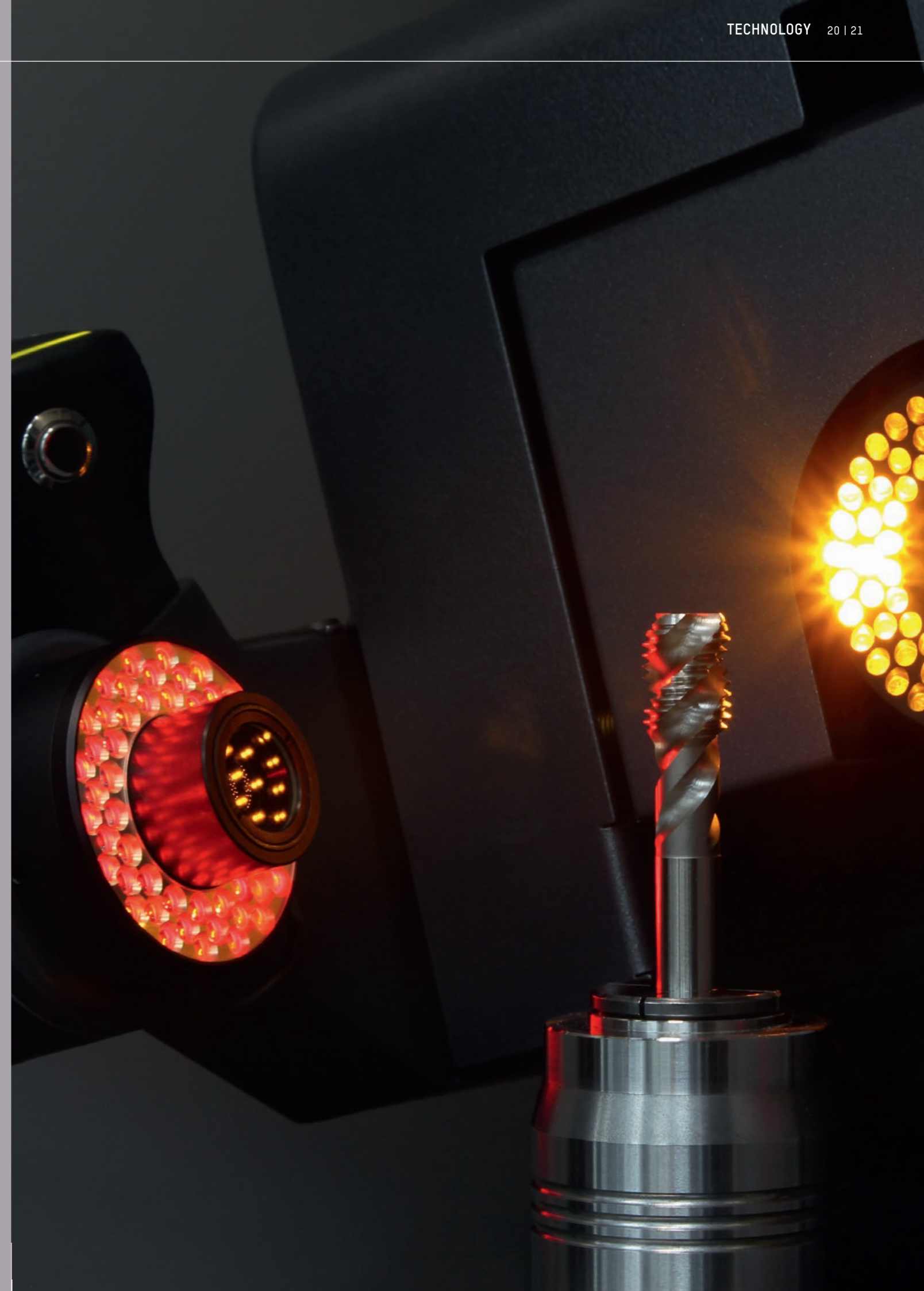

Thread Types in Focus, Fascination in Detail

Measurable parameters at a glance:

- Chamfer diameter d_5
- Chamfer angle β
- Chamfer length L_1
- Chamfer relief h_a
- Thread angle α
- Height of fundamental triangle H
- Root truncation C
- Pitch P
- Pitch diameter d_2
- Major diameter d
- Radial runout major diameter \rightarrow
- Minor diameter d_3
- Taper pitch diameter Δ_2
- Taper major diameter Δ_1
- Taper minor diameter Δ_3
- Flank diameter (offset teeth) D_{ave}
- Length of thread part L_2
- Diameter of shank recession d_7
- Shank diameter d_4
- Land width T
- Flute width S
- Length of spiral point L_3
- Slope angle spiral point γ_3
- Inclination angle spiral point λ
- Cutting angle spiral point γ_2
- Cutting angle γ_1
- Flute core diameter d_6
- Flute length L_4
- Major diameter relief h_1
- Pitch diameter relief h_2

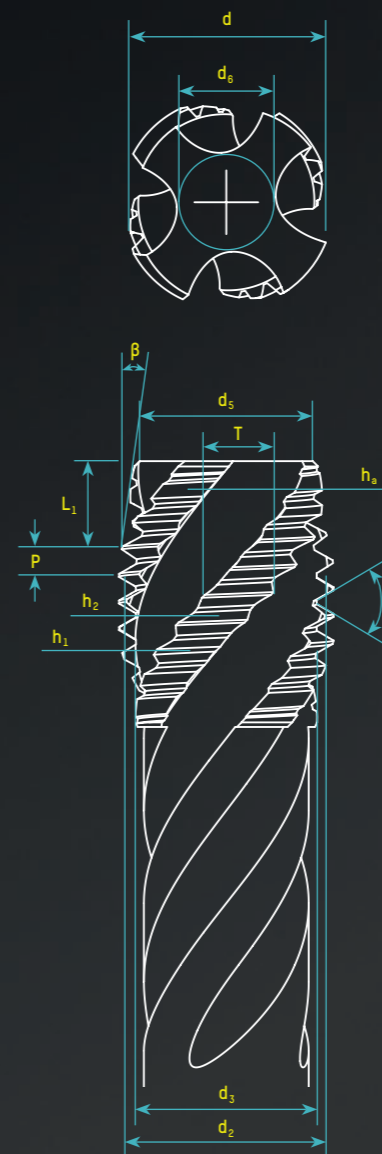

Measuring technology for threading tools – specially developed for the requirements of threading tools – enables fully automatic measurement in transmitted and incident light of all relevant parameters of taps, thread cutters and thread formers.

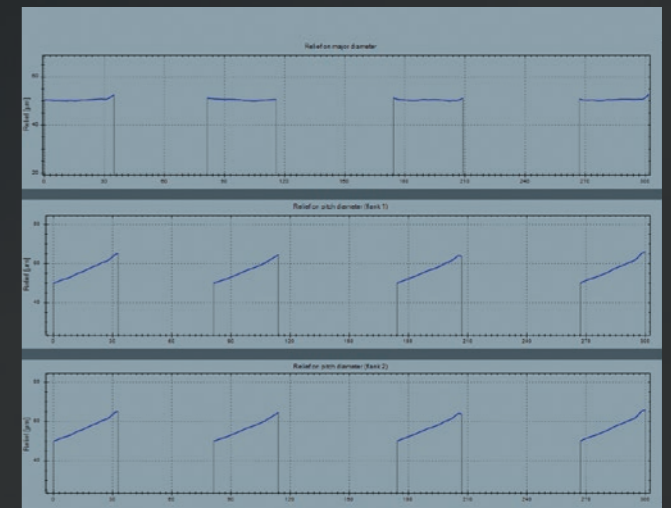

Graphic display – of specific measured values such as the relief on the major or flank diameter, in addition to the numeric measurement results.

Options/Accessories

Automatic sliding door

Before starting the measuring process, the sliding door of the measuring machine can be conveniently and easily closed pneumatically via the software and opened again once the measuring process is completed.



Vibration decoupling

With a dead weight of approx. 650 kg and isolators, the solid vibration platform absorbs external vibration influences at the installation site. The isolators are supplied with compressed air at 6 bar.



Scanning probe

For electronic tactile measurement of, for example, the thread relief on taps. Available with probe inserts from D 0.3 mm to D 2 mm.



Measuring and inspection tools

For periodic on-site inspection of the measuring machine and to verify the accuracy of transmitted and incident light measurements, ZOLLER offers appropriate measuring and inspection tools for your measuring machine, such as test mandrels, diameter and angle test gauges.

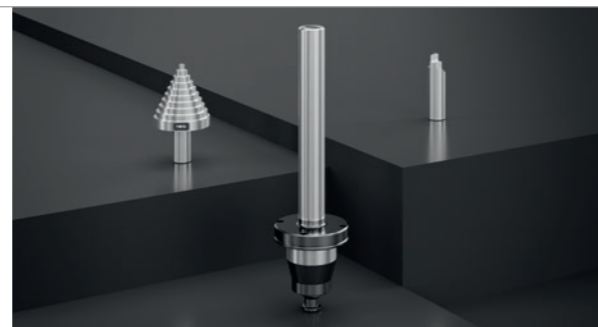

Emergency stop control on the »cockpit«

Allows all motorized movements to be stopped simultaneously in order to further increase the high level of safety of the Uhing drives. The power supply to the electronic components is maintained, so there is no risk of data loss.



Safety package

Important operating elements are located on the front of the measuring machine. This means you always have unrestricted access to the emergency stop switch, the reset button, the membrane keypad and the button for starting measurement processes.



Manual RFID read/write station »mslz«

For manual writing/reading of the code carrier on the tool holder via a handheld reader.



UPS system

The UPS system for uninterruptible power supply ensures that your computer is shut down properly in the case of a power failure to prevent data loss. Mains voltages of 230 V~ (Europe) and 120 V~ (USA) are available.



Intelligent 24/7 Presence

ZOLLER »roboSet 2« – automates your »genius«. Cleans, loads, labels and organizes your tools completely without manpower.

After loading the pallets with tools, the automatic intermediate sleeve change starts. In the upstream tool cleaning »roboClean« the tools are cleaned in an ultrasonic bath before they are clamped and measured in the ZOLLER »genius«.

All measurements are fully documented. After the measurement, the tools are marked with ZOLLER »roboMark« – a laser flexibly marks the shank of the tool within milliseconds with values and other data individually determined during the measuring process.

This is how ZOLLER sustainability works: With the »roboSet 2« you manufacture in a climate-conscious way and maximize the overall efficiency of your processes. Let modular robot precision work for you: Automated technology – state-of-the-art, flexible, 24/7.

Advantages of ZOLLER »roboSet 2«

- Automatic measurement and inspection, 24/7
- High loading capacity
- Flexible pallet management system

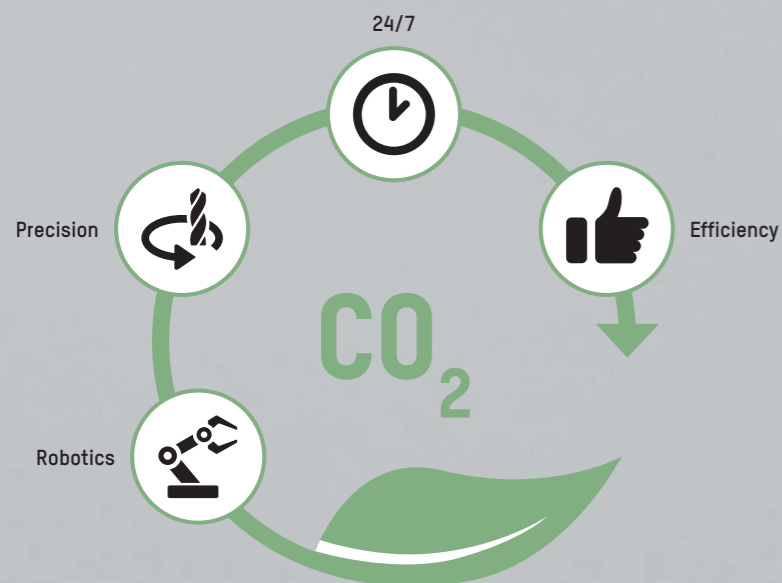

»roboSet 2« Functionality

Robot

The robot integrated in the »roboSet 2« makes it possible to guarantee a high tool throughput 24/7 without an operator. The robot performs even complex and lengthy measuring tasks independently – maximum process reliability and measuring accuracy are always guaranteed. The integrated force/torque sensor also offers you the option of reliably inserting shank tools into tight fits such as intermediate sleeves.



Automatic intermediate sleeve change

The intermediate sleeves are changed fully automatically. This makes it possible to measure and document different tool types within a pallet management system and even within a pallet.

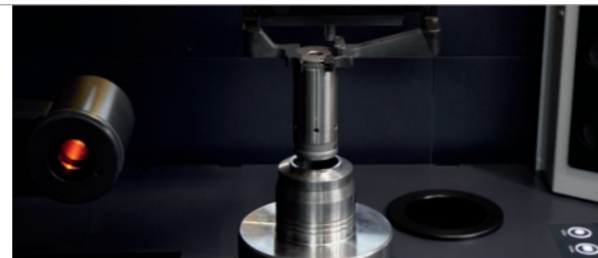

Pallet management

Before the Automation Solution »roboSet 2« can start its work process, only the loading of the tools via the pallet management has to be defined by an operator in the software »pilot 4.0«. Thanks to the multi-pallet system (eight pallets as standard, nine as an option), large quantities can be processed and documented fully automatically. Overall, well-organized pallet management makes a significant contribution to process optimization, provides flexibility to handle different batch sizes and helps to move goods more efficiently and sustainably.

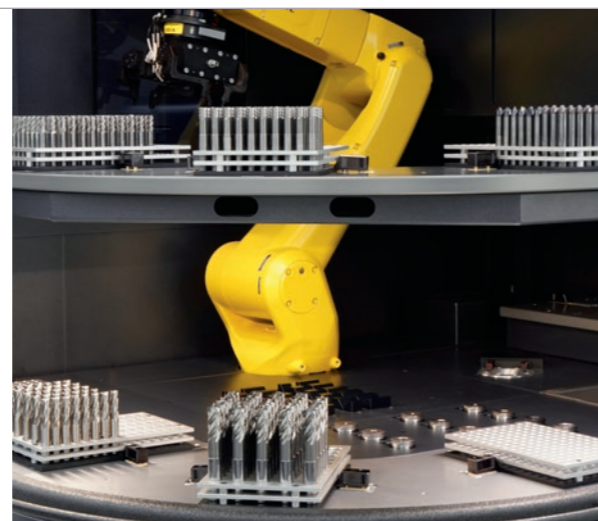

Camera for process monitoring

Thanks to an integrated camera, which is available as an option, any irregularities that occur can be rectified more quickly and specifically by ZOLLER service personnel.



»roboClean«

In the upstream tool cutting edge cleaning »roboClean« the cutting edges of pre-cleaned shank tools are cleaned fully automatically in an ultrasonic bath and dust is removed. Air nozzles then make sure that the shank tools are dried. This ensures precise measurement results.

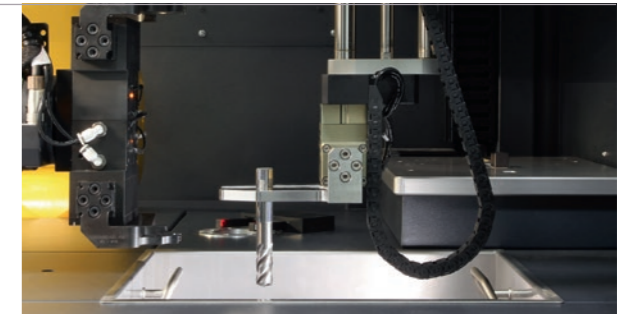

»roboMark«

The ZOLLER laser marking system »roboMark« is used to mark tools that have been measured within tolerance, either on the circumference or the end of the shank. The marking itself is individual and offers many different setting options. QR or DataMatrix codes can also be applied without additional effort and enable traceability of the respective tool via the link to the tool database.

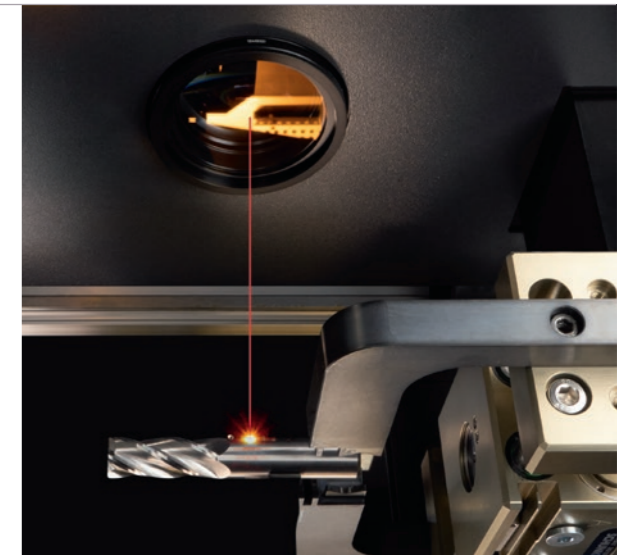

Weldon detection

Within the »roboSet 2« automatic and contactless weldon detection takes place. The tool is aligned accordingly so that it can be safely picked up by the robot and labeled with »roboMark« at the appropriate position.



QR code recognition

During automatic tool recognition, QR codes, DataMatrix codes etc. are read via an integrated scanner. Thanks to the interface to ZOLLER TMS Tool Management Solutions, all information on the scanned tools is accessible and links to external workstations (e. g. to the regrinding counter) can also be implemented.



Two-Dimensional Guaranteed Quality

The demands in quality management are constantly increasing. Therefore, you must be able to rely on the constant measuring deviations of your machines. In ZOLLER measuring machines, high-precision calibration standards made of Borofloatglas® are used to determine the length measurement deviations based on the DIN EN ISO 10360 standard. In accordance with this standard, at least three measuring sequences (25,326 relationships) are carried out. With this procedure, the accuracy of the ZOLLER measuring machines is documented in two dimensions and can be traced at any time.

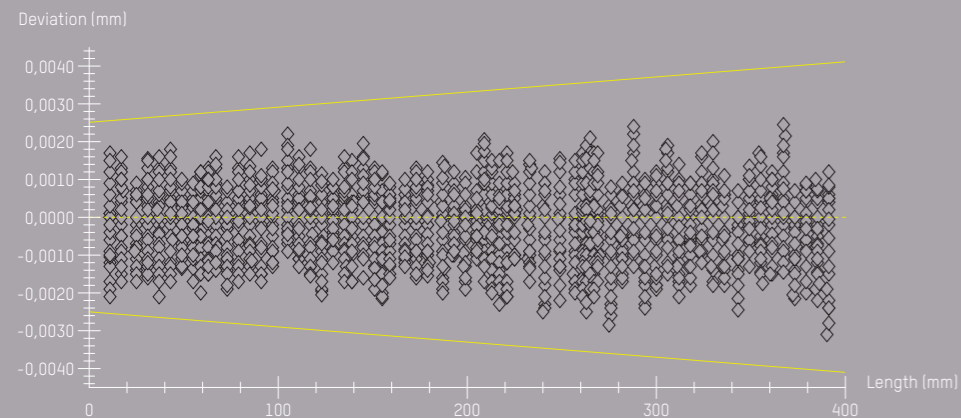

Two-dimensional – based on DIN EN ISO 10360, $E_{xy} = 2.5 \mu\text{m} + (L/250 \text{ mm}) \mu\text{m}$

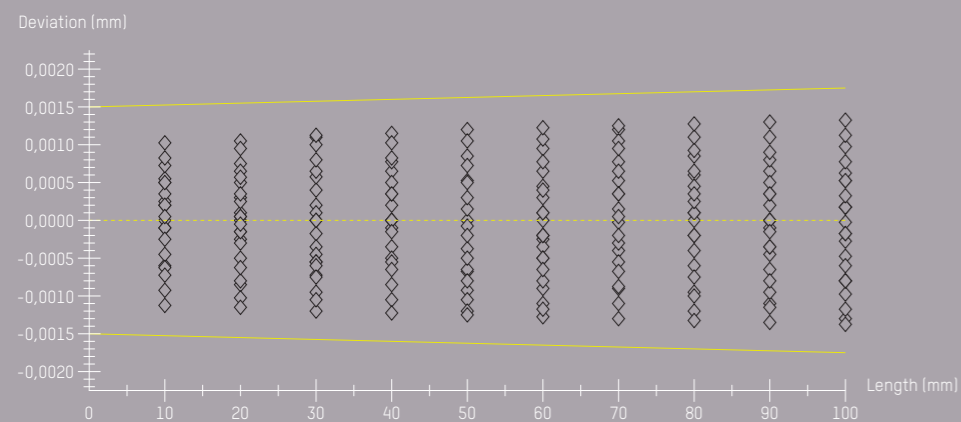

One-dimensional – according to VDI/VDE 2617, $E_x = 1.5 \mu\text{m} + (L/300 \text{ mm}) \mu\text{m}$



Process Optimization – Precisely Networked

ZOLLER has developed world-leading networking options and interfaces for tool data. Thanks to intelligent networking processes, the µm-precise measurement data from the ZOLLER measuring machine »genius« unleash their full potential. The tool grinding program is created from the CAD/CAM data of a new tool at the programming station and the grinding process is simulated. The program is sent to the grinding machine and to the ZOLLER measuring machine. ZOLLER generates a fully automatic measuring sequence for you, you do not need any programming knowledge. The measuring machine then determines the deviations between the nominal and actual data for the first ground tool and transfers the adjustments to the grinding machine. Series production begins with the second tool.

The basis for smooth processes are the ZOLLER interfaces, which open up completely new savings potentials and productivity increases.

ZOLLER measuring machines communicate with the following control systems:



As well as other specific interfaces



- 1 Definition of the tool/programming/data transfer
- 2 Creation of the measuring sequence in »caz« or on the measuring machine
- 3 Grinding of the first tool and transfer to the measuring machine
- 4 Tool measurement and transfer of the correction values
- 5 Series production with random sampling or 100% inspection
- 6 Delivery with inspection report

Installation Dimensions and Technical Data

Technical data »genius«				
Maximum tool length Z	Maximum tool diameter D	Maximum snap gauge diameter d	Number of axes	Weight
600 mm	400/260 mm	100 mm	5-6	~ 820 kg

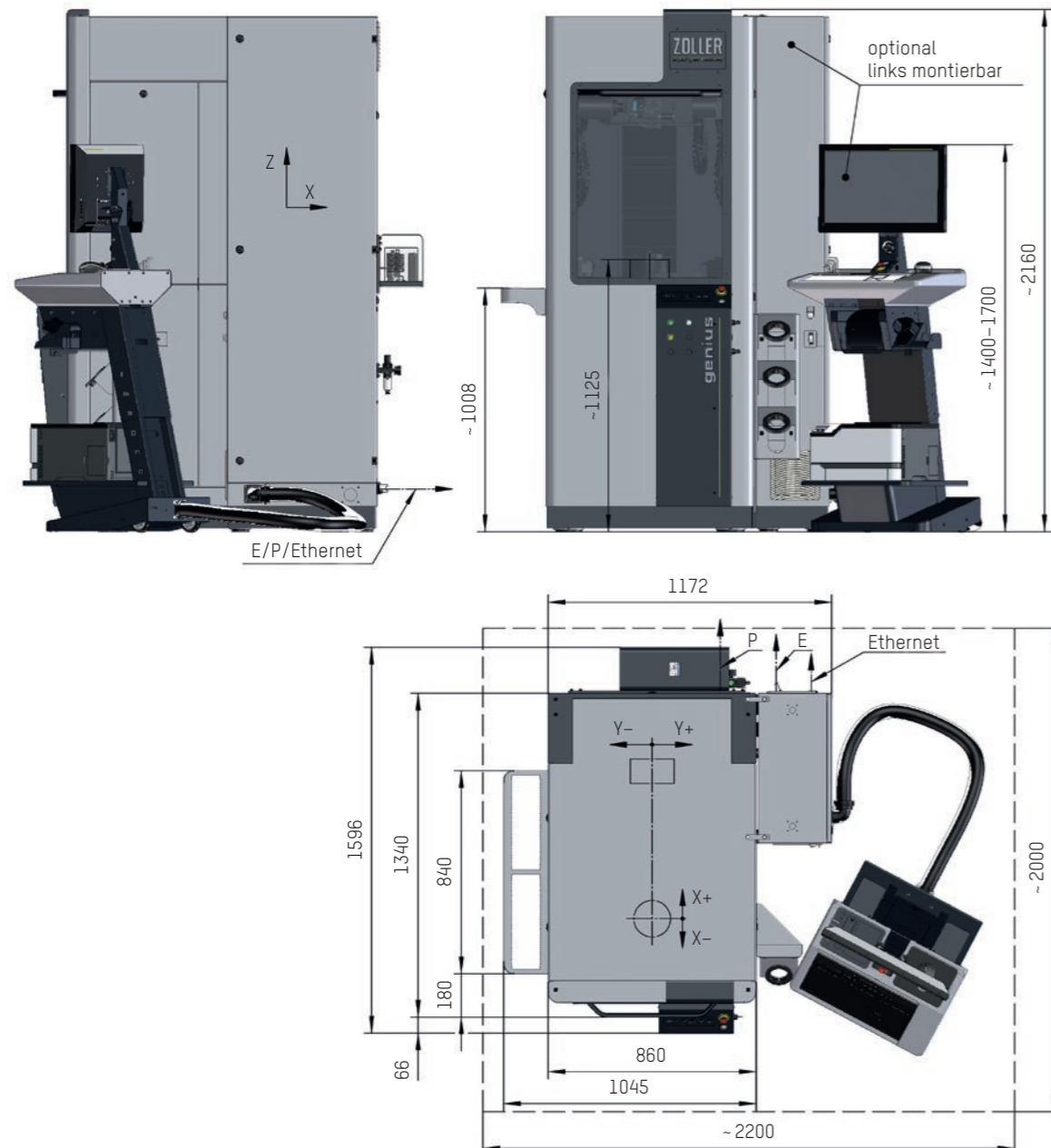

Application	
2D parameters Incident light	
Diameter standard 2-100 mm	●
Micro tools 0.1-10 mm	⊙
3D parameter incident light	
Partial	●
Surface-related	●
Measuring tasks	
Threading tools	⊙
Sensors configuration	
Optics transmitted light	
Transmitted light camera HR70, BF approx. 4.0 x 3.6 mm²	●
Transmitted light camera 5 Mpx, BF approx. 4.4 x 4.0 mm²	⊙
Transmitted light camera WF, BF approx. 15.5 x 14.1 mm²	⊙
Optics incident light	
Incident light camera HR50 Standard, BF approx. 1.1 x 1.0 mm²	●
Incident light camera HR50 Micro, BF approx. 0.4 x 0.4 mm²	⊙
Tactile	
Scanning probe	⊙

Measuring machine configuration	
Spindle	
High-precision spindle »ace«	●
High-precision spindle SK 50	⊙
ROD	●
Hollow encoder	⊙
Linear drive	
ZOLLER power transmission	●
X-, Y-, Z-axis in column design	●
Optics drive	
Swivel axis incident light	●
Swivel axis incident light & transmitted light	⊙
Vibration damping	
Leveling element on machine feet	●
Active vibration decoupling	⊙
Material	
Light metal alloy	●
Accuracy	
$E_{xy} = 2.5 \mu\text{m} + (L/250 \text{ mm}) \mu\text{m}$	●
$E_x = 1.5 \mu\text{m} + (L/300 \text{ mm}) \mu\text{m}$	●

Pioneering Efficiency for your Grinding Shop

The highest efficiency potential lies outside the grinding machine: ZOLLER Solutions stand for your future – we make you more successful. Because if you manufacture faster and more efficiently, you work more economically in order to be able to invest in the future. If economic progress is your goal, then ZOLLER is your partner.



In Germany at Home – Around the World for You

Your Advantage
ZOLLER presence
Global. Close. Personal.

ZOLLER quality is “made in Germany” – and there for you, anywhere in the world.

Our company has its own locations and branches at 85 sites in 62 countries, guaranteeing we are close to customers and can provide first-class, personal customer service in local markets.

- Parent company
- Headquarters
- Branch office
- Representative

GERMANY

HEADQUARTERS

E. ZOLLER GmbH & Co. KG
Einstell- und Messgeräte
Gottlieb-Daimler-Straße 19
D-74385 Pleidelsheim
Tel: +49 7144 8970-0
Fax: +49 7144 8970-70191
post@zoller.info | www.zoller.info

ZOLLER NORTH

E. ZOLLER GmbH & Co. KG
Service- und Vertriebszentrum
D-30179 Hannover

ZOLLER EAST

E. ZOLLER GmbH & Co. KG
Service- und Vertriebszentrum
D-04158 Leipzig

ZOLLER WEST

E. ZOLLER GmbH & Co. KG
Service- und Vertriebszentrum
D-40764 Langenfeld

EUROPE

AUSTRIA

ZOLLER Austria GmbH
A-4910 Ried im Innkreis
office@zoller-a.at | www.zoller-a.at

SWITZERLAND

ZOLLER Schweiz GmbH
CH-9016 St. Gallen
info@zoller-ch.com | www.zoller-ch.com

FRANCE

ZOLLER France
F-67380 Lingolsheim
info@zoller.fr | www.zoller.fr

SPAIN + PORTUGAL

ZOLLER Ibérica S.L.
E-08005 Barcelona
correo@zoller.info | www.zoller.info

SWEDEN

ZOLLER Sweden AB
SE-63221 Eskilstuna
info@zoller-se.com | www.zoller.info

TURKEY

ZOLLER Ölçüm Teknolojileri San.ve Tic. Ltd. Sti.
TR-16120 Nilüfer / Bursa
info@zoller-tr.com | www.zoller-tr.com

RUSSIA

LLC ZOLLER Russia
RU-111123 Moscow, Russia
info@zoller-ru.com | www.zoller-ru.com

ISRAEL

ZOLLER Israel GmbH
Ramat Yishay 3009500
info@zoller-il.com | www.zoller.info

POLAND

ZOLLER Polska Sp. z o.o.
63-100 Śrem
biuro@zoller-a.at | www.zoller.net.pl

CZECH REPUBLIC + SLOVAKIA

ZOLLER Czech s.r.o.
602 02 Brno
info@zoller.cz | www.zoller.cz

AMERICA

USA

ZOLLER Inc.
North American Headquarters
USA-48108 Ann Arbor, MI
sales@zoller-usa.com | www.zoller-usa.com

ZOLLER Inc. Pacific

USA-90503 Torrance, CA
sales@zoller-usa.com | www.zoller-usa.com

CANADA

ZOLLER Canada Inc.
CAN-LSN 864 Mississauga, ON
sales@zoller-canada.com | www.zoller-canada.com

MEXICO

ZOLLER Tecnologías S de R.L. de C.V.
MEX-C.P. 76030 San Angel Querétaro
sales@zoller-mexico.com | www.zoller-mexico.com

BRAZIL

ZOLLER do Brasil
BRA-CEP 13284-198 Nova Vinhedo,
Vinhedo - São Paulo
comercial@zoller-br.com | www.zoller-br.com

ASIA

INDIA

ZOLLER India Private Ltd.
IN-Pune 411019 Maharashtra, India
info@zoller-in.com | www.zoller-in.com

CHINA

ZOLLER Shanghai, Ltd.
Asia Pacific Regional Headquarter
RC-201108 Shanghai
info@zoller-cn.com | www.zoller-cn.com

ZOLLER Asia Pacific, Ltd.

RC-Kowloon, Hongkong
info@zoller-cn.com | www.zoller-cn.com

JAPAN

ZOLLER Japan K. K.
JP-564-0037 Osaka, Japan
info@zoller-jp.com | www.zoller-jp.com

THAILAND

ZOLLER (Thailand) Co. Ltd.
Amphur Muang Chonburi, TH-20000 Thailand
info@zoller-in.com | www.zoller-th.com

INDONESIA

ZOLLER Singapore Pte. Ltd
Indonesia Representative Office
Tambun-17510, Bekasi, Jawa Barat
info@zoller-in.com | www.zoller-in.com

SINGAPORE

ZOLLER Singapore Pte. Ltd
SG-199589 Singapore
info@zoller-in.com | www.zoller.info

MALAYSIA

ZOLLER MALAYSIA SDN. BHD.
Malaysia Representative Office
MY-Petaling Jaya | Selangor Darul Ehsan, Malaysia
lau@zoller-my.com | www.zoller-in.com

VIETNAM

ZOLLER Vietnam
VNM-Ho Chi Minh City, Vietnam
info@zoller-in.com | www.zoller-in.com

KOREA

ZOLLER Korea Co., Ltd.
KOR-15119 - Siheung-Si, Gyeonggi-Do, Südkorea
info@zoller-kr.com | www.zoller-kr.com

REPRESENTATIVES

Argentina, Australia, Belgium, Bolivia, Chile, Colombia, Costa Rica, Croatia, Denmark, Estonia, Finland, Great Britain, Hungary, Iran, Ireland, Italy, Lettland, Latvia, Luxembourg, New Zealand, The Netherlands, Norway, Pakistan, Peru, Romania, Saudi Arabia, South Africa, Southern Tyrol, Taiwan, United Arab Emirates, Venezuela.



Your Customer Portal
www.myzoller.com

simple. direct. online.

ZOLLER Solutions

More speed, higher quality, safe processes – with ZOLLER, you increase the efficiency of your production. ZOLLER offers you outstandingly precise devices for adjusting, measuring and testing cutting tools, software, interfaces, cloud services and solutions for the automation of tool processes. You can combine all of this to create your individual system solution – on your way to the smart factory.

Presetting & Measuring

Tool Management

Inspection & Measuring

Automation

Everything from a Single Source.
Everything for your Success.
Everything with ZOLLER Solutions.

ZOLLER
expect great measures

Headquarters in Pleidelsheim
E. ZOLLER GmbH & Co. KG
Tool presetter and measuring machines
Gottlieb-Daimler-Straße 19 | D-74385 Pleidelsheim
Phone: +49 7144 8970-0 | Fax: +49 7144 8970-70191
post@zoller.info | www.zoller.info